

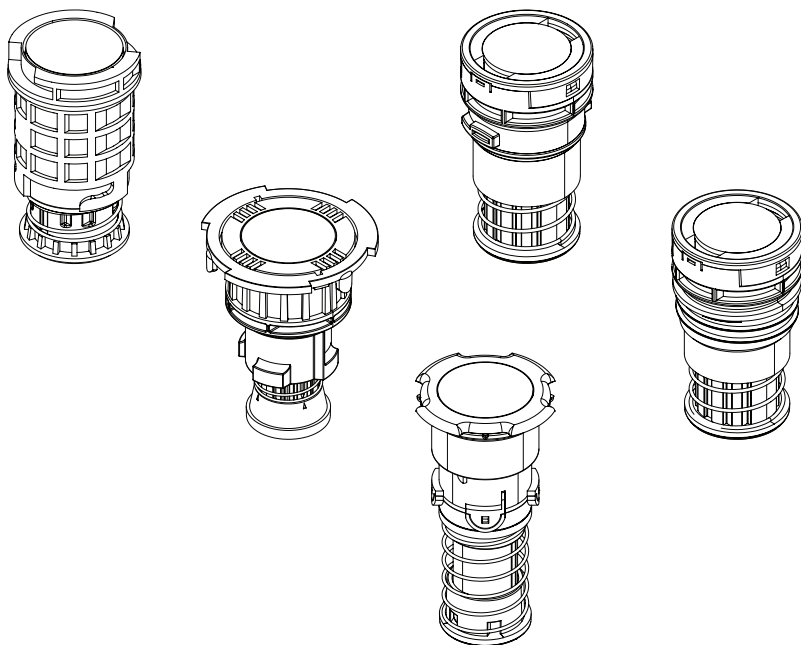

QUIKJET™

RETRO IN-FLOOR CLEANING HEADS



INSTALLATION AND USER'S GUIDE

IMPORTANT SAFETY INSTRUCTIONS
READ AND FOLLOW ALL INSTRUCTIONS
SAVE THESE INSTRUCTIONS

CUSTOMER SERVICE / TECHNICAL SUPPORT

Hours: 9:00AM to 7:00PM EST (6:00AM - 4:00PM PST)

Call: (800) 831-7133

Visit: www.pentair.com

Fax: (800) 284-4151

TABLE OF CONTENTS

BLUE SQUARE™ Q360 RETRO IN-FLOOR CLEANING HEAD	2
PARAMOUNT™ PCC2000 RETRO IN-FLOOR CLEANING HEAD	4
PARAMOUNT™ PV3 & PVR RETRO IN-FLOOR CLEANING HEAD	6
CARETAKER™ CT99 BAYONET & THREADED RETRO IN-FLOOR CLEANING HEAD	9

BLUE SQUARE™ Q360 RETRO IN-FLOOR CLEANING HEAD

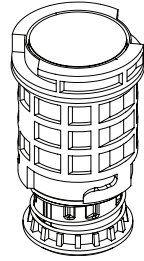

Follow the instructions below to properly install QuikJet cleaning heads into your existing in-floor cleaning system:

1. **Disconnect power to the filter pump at the circuit breaker.**
2. Attach cleaning head to Blue Square™ removal tool or Pentair removal tool (*P/N 220017).
Note: *Available for purchase separately.
3. Rotate the tool a quarter turn counterclockwise to unlock and remove the cleaning head. See **Figure 1**.
4. Push the bottom of the QuikJet cleaning head upwards to expose the QuikJet nozzle.
5. Refer to **Figure 2** to determine the correct QuikJet nozzle orifice setting.

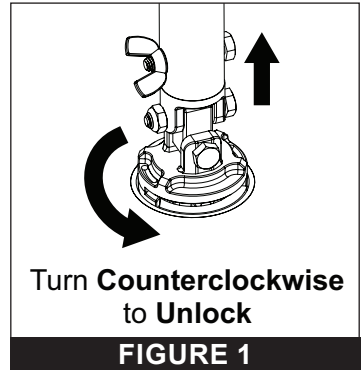

- Continued on next page -

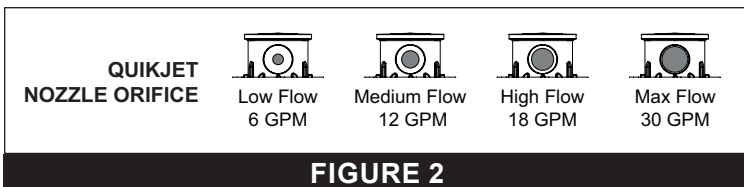

6. While firmly holding the *Outer Housing (1)*, fully extend the *Spring Tube (2)* and rotate the *Nozzle (3)* a quarter turn counterclockwise to unlock and remove it.
See **Figure 3** below.
7. Ensure the nozzle orifice is positioned correctly and place the *Nozzle (3)* back into the *Spring Tube (2)*.
See **Figure 3** below.
8. Turn the *Nozzle (3)* a quarter turn clockwise to lock it into place.
See **Figure 3** below.
9. Press the top of the assembled cleaning head onto the removal tool.
10. Guide the cleaning head into the hole in the pool floor.
11. Rotate the tool a quarter turn clockwise to lock the cleaning head into place. See **Figure 4** below.
12. Once all cleaning heads have been replaced, cycle through the cleaning process to ensure proper installation.

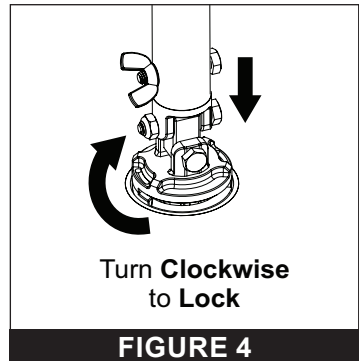
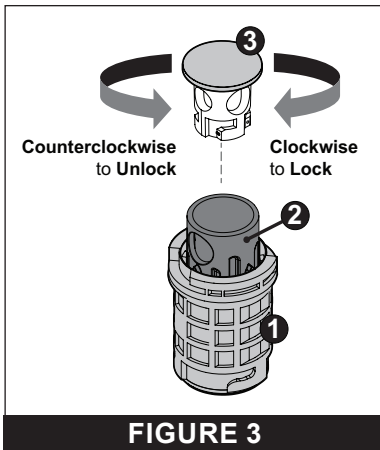

BLUESQUARE RETRO INTERNALS WITH RATCHETING HEAD	
PART NUMBER	PRODUCT NAME & DESCRIPTION
220065	BlueSquare Retro Ratcheting Head Multi-Orifice Cap, White
220066	BlueSquare Retro Ratcheting Head Multi-Orifice Cap, Gray
220067	BlueSquare Retro Ratcheting Head Multi-Orifice Cap, Black

PARAMOUNT™ PCC2000 RETRO IN-FLOOR CLEANING HEAD

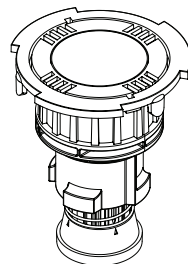

Follow the instructions below to properly install QuikJet cleaning heads into your existing in-floor cleaning system:

1. **Disconnect power to the filter pump at the circuit breaker.**
2. Attach cleaning head to Paramount™ removal tool or Pentair removal tool (*P/N 220019).
Note: *Available for purchase separately.
3. Rotate the tool a quarter turn counterclockwise to unlock and remove the cleaning head. See **Figure 5**.
4. Push the bottom of the QuikJet cleaning head upwards to expose the QuikJet nozzle.
5. Refer to **Figure 6** to determine the correct QuikJet nozzle orifice setting.

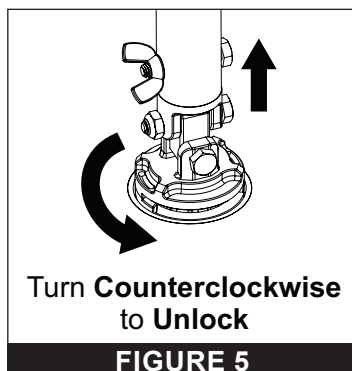

- Continued on next page -

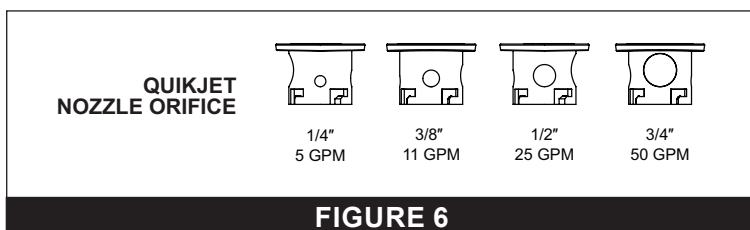

6. While firmly holding the *Outer Housing (1)*, fully extend the *Spring Tube (2)* and rotate the *Nozzle (3)* a quarter turn counterclockwise to unlock and remove it.
See **Figure 7** below.
7. Ensure the nozzle orifice is positioned correctly and place the *Nozzle (3)* back into the *Spring Tube (2)*.
See **Figure 7** below.
8. Turn the *Nozzle (3)* a quarter turn clockwise to lock it into place.
See **Figure 7** below.
9. Press the top of the assembled cleaning head onto the removal tool.
10. Guide the cleaning head into the hole in the pool floor.
11. Rotate the tool a quarter turn clockwise to lock the cleaning head into place. See **Figure 8** below.
12. Once all cleaning heads have been replaced, cycle through the cleaning process to ensure proper installation.

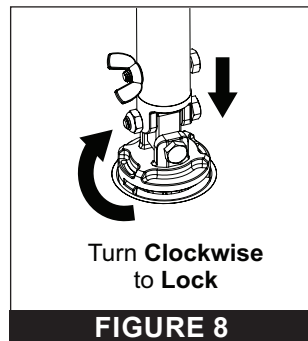
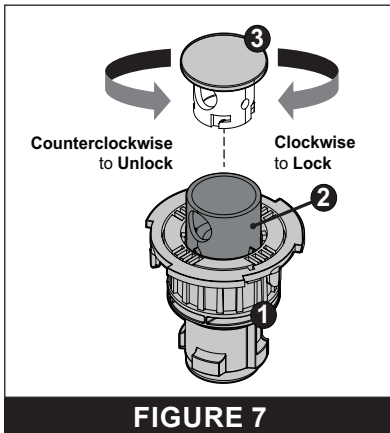

PARAMOUNT PCC2000 RETRO INTERNALS WITH ROTATING NOZZLES*	
PART NUMBER	PRODUCT NAME & DESCRIPTION
220084	PCC2000 Retro Rotating Nozzle, White
220085	PCC2000 Retro Rotating Nozzle, Light Gray
220086	PCC2000 Retro Rotating Nozzle, Gray
220087	PCC2000 Retro Rotating Nozzle, Black
PARAMOUNT PCC2000 RETRO INTERNALS WITH FIXED NOZZLES*	
220088	PCC2000 Retro Fixed Nozzle, White
220089	PCC2000 Retro Fixed Nozzle, Light Gray
220090	PCC2000 Retro Fixed Nozzle, Gray
220091	PCC2000 Retro Fixed Nozzle, Black

*Compatible with PCC2000, Vanquish, Vantage, & Vanish

PARAMOUNT™ PV3 & PVR RETRO IN-FLOOR CLEANING HEAD

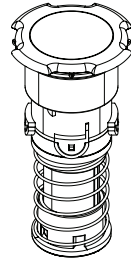

Follow the instructions below to properly install QuikJet cleaning heads into your existing in-floor cleaning system:

1. **Disconnect power to the filter pump at the circuit breaker.**
2. Attach cleaning head to Paramount™ removal tool or Pentair removal tool (*P/N 220018).
Note: *Available for purchase separately.
3. Rotate the tool a quarter turn counterclockwise to unlock and remove the cleaning head. See **Figure 9**.
4. Push the bottom of the QuikJet cleaning head upwards to expose the QuikJet nozzle.
5. Refer to **Figure 10** to determine the correct QuikJet nozzle orifice setting.

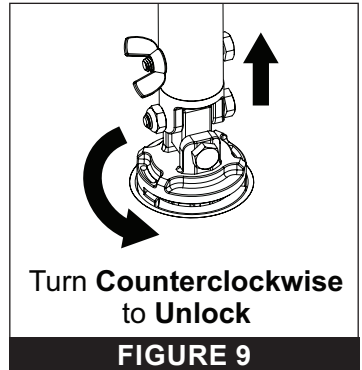

- Continued on next page -

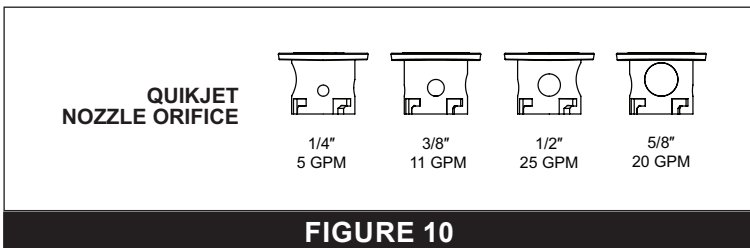

6. While firmly holding the *Outer Housing (1)*, fully extend the *Spring Tube (2)* and rotate the *Nozzle (3)* a quarter turn counterclockwise to unlock and remove it.
See **Figure 11** below.
7. Ensure the nozzle orifice is positioned correctly and place the *Nozzle (3)* back into the *Spring Tube (2)*.
See **Figure 11** below.
8. Turn the *Nozzle (3)* a quarter turn clockwise to lock it into place.
See **Figure 11** below.
9. Press the top of the assembled cleaning head onto the removal tool.
10. Guide the cleaning head into the hole in the pool floor.
11. Rotate the tool a quarter turn clockwise to lock the cleaning head into place. See **Figure 12** below.
12. Once all cleaning heads have been replaced, cycle through the cleaning process to ensure proper installation.

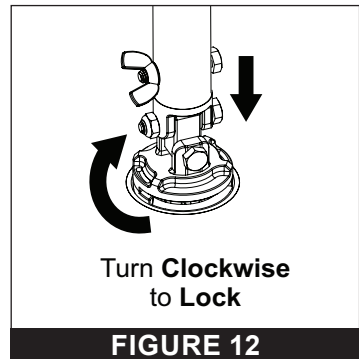
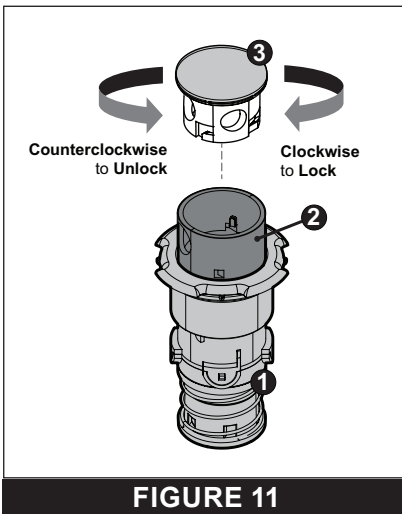

PARAMOUNT PV3 RETRO INTERNALS WITH RATCHETING NOZZLES**	
PART NUMBER	PRODUCT NAME & DESCRIPTION
220076	PV3 Retro Ratcheting Nozzle Multi-Orifice Cap, White
220077	PV3 Retro Ratcheting Nozzle Multi-Orifice Cap, Light Gray
220078	PV3 Retro Ratcheting Nozzle Multi-Orifice Cap, Gray
220079	PV3 Retro Ratcheting Nozzle Multi-Orifice Cap, Black
PARAMOUNT PV3 RETRO INTERNALS WITH WEIGHTED NOZZLES**	
220080	PV3 Retro Weighted Nozzle Multi-Orifice Cap, White
220081	PV3 Retro Weighted Nozzle Multi-Orifice Cap, Light Gray
220082	PV3 Retro Weighted Nozzle Multi-Orifice Cap, Gray
220083	PV3 Retro Weighted Nozzle Multi-Orifice Cap, Black
**Compatible with PV3, PVR, Cyclean, Eco System, & Eco Pool	
PARAMOUNT PV3 RETRO INTERNALS WITH SPINNING HEADS	
230349	PV3 Retro Spinning Head Multi-Orifice Cap, White
230350	PV3 Retro Spinning Head Multi-Orifice Cap, Light Gray
230351	PV3 Retro Spinning Head Multi-Orifice Cap, Dark Gray
230352	PV3 Retro Spinning Head Multi-Orifice Cap, Black

CARETAKER™ CT99 BAYONET & THREADED RETRO IN-FLOOR CLEANING HEAD

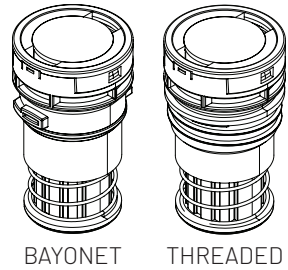

Follow the instructions below to properly install QuikJet cleaning heads into your existing in-floor cleaning system:

1. **Disconnect power to the filter pump at the circuit breaker.**
2. Attach cleaning head to Caretaker™ removal tool or Pentair removal tool (*P/N 220016).

Note: *Available for purchase separately.

3. **Bayonet:** To remove bayonet locking cleaning head, rotate tool a quarter turn counterclockwise to unlock. See **Figure 13**.

Threaded: To remove threaded cleaning head, turn *clockwise* until head is removed from floor fitting.

4. Push the bottom of the QuikJet cleaning head upwards to expose the QuikJet nozzle.
5. Refer to **Figure 14** to determine the correct QuikJet nozzle orifice setting.

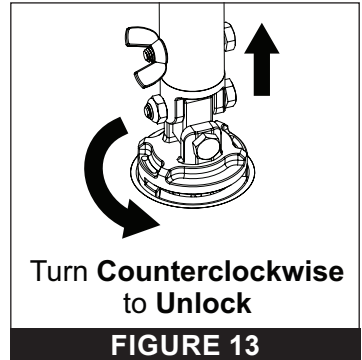

- Continued on next page -

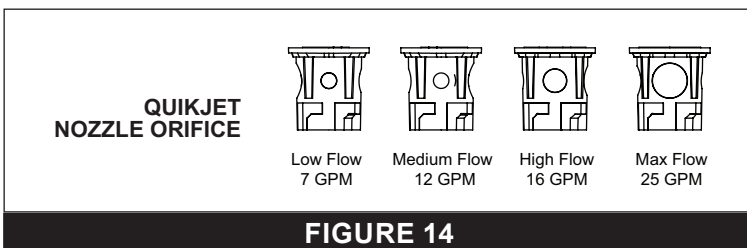

6. While firmly holding the *Outer Housing (1)*, fully extend the *Spring Tube (2)* and rotate the *Nozzle (3)* a quarter turn counterclockwise to unlock and remove it. See **Figure 15** below.
7. Ensure the nozzle orifice is positioned correctly and place the *Nozzle (3)* back into the *Spring Tube (2)*. See **Figure 15** below.
8. Turn the *Nozzle (3)* a quarter turn clockwise to lock it into place. See **Figure 15** below.
9. Press the top of the assembled cleaning head onto the removal tool.
10. Guide the cleaning head into the hole in the pool floor.
11. **Bayonet:** To lock bayonet cleaning head into place, rotate tool a quarter turn clockwise. See **Figure 16** below.
Threaded: To lock threaded cleaning head into place, turn cleaning head *counterclockwise* until firm.
12. Once all cleaning heads have been replaced, cycle through the cleaning process to ensure proper installation.

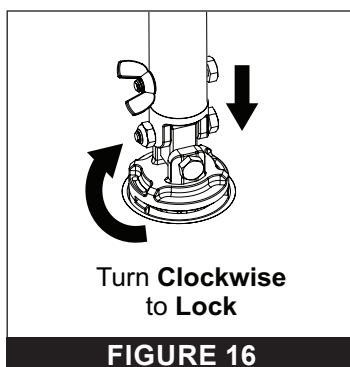
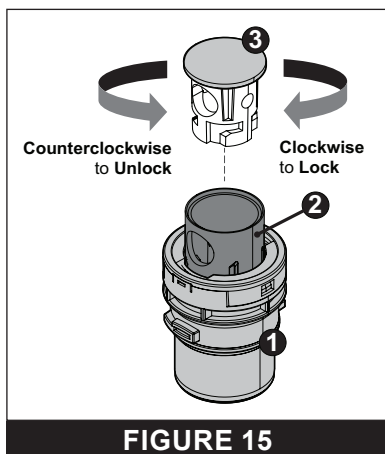

CARETAKER RETRO INTERNALS WITH THREADED RATCHETING HEAD	
PART NUMBER	PRODUCT NAME & DESCRIPTION
220068	Caretaker Threaded Ratcheting Head Multi-Orifice Cap, White
220069	Caretaker Threaded Ratcheting Head Multi-Orifice Cap, Dark Gray
220070	Caretaker Threaded Ratcheting Head Multi-Orifice Cap, Gray
220071	Caretaker Threaded Ratcheting Head Multi-Orifice Cap, Black
CARETAKER RETRO INTERNALS WITH LOCKING HEAD	
220072	Caretaker99 Retro Locking Head Multi-Orifice Cap, White
220073	Caretaker99 Retro Locking Head Multi-Orifice Cap, Dark Gray
220074	Caretaker99 Retro Locking Head Multi-Orifice Cap, Gray
220075	Caretaker99 Retro Locking Head Multi-Orifice Cap, Black



1620 HAWKINS AVE., SANFORD, NC 27330 • (919) 566-8000
10951 WEST LOS ANGELES AVE., MOORPARK, CA 93021 • (805) 553-5000

All indicated Pentair trademarks and logos are property of Pentair. Third party registered and unregistered trademarks and logos are the property of their respective owners. Blue Square® and Q360® are trademarks of Blue Square Manufacturing, LLC in the United States and/or other countries. Zodiac® and Caretaker™ are trademarks of Zodiac Pool Systems, Inc. in the United States and/or other countries. Hayward® and Paramount® are trademarks of Hayward Industries, Inc. in the United States and/or other countries.

© 2024 Pentair. All rights reserved. WWW.PENTAIR.COM



P/N 230358 REV. A 4/10/24