

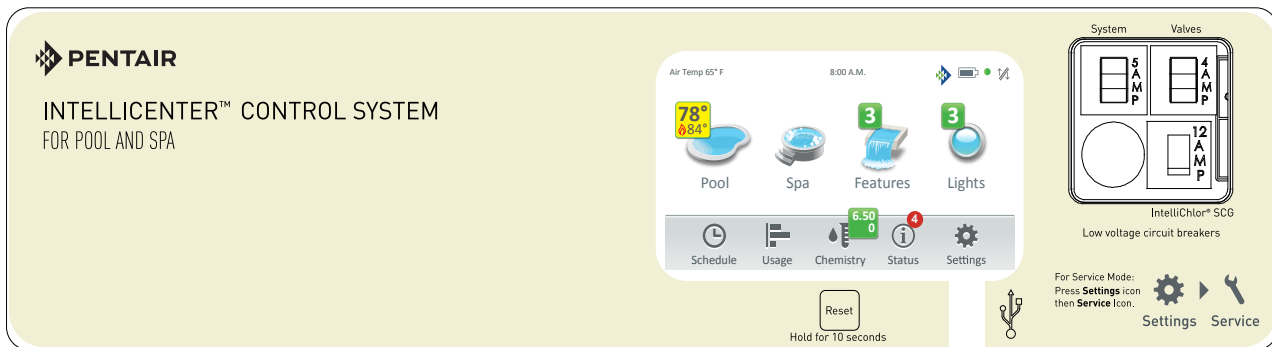

EASYTOUCH® / INTELLITOUCH® CONTROL SYSTEM UPGRADE TO INTELLICENTER™ CONTROL SYSTEM (For Systems 2012 or Newer)



INSTALLATION GUIDE

IMPORTANT SAFETY INSTRUCTIONS
READ AND FOLLOW ALL INSTRUCTIONS
SAVE THESE INSTRUCTIONS

CUSTOMER SERVICE / TECHNICAL SUPPORT

Customer Service
 8 AM to 5.30 PM — Eastern and Pacific Times
 Phone: (800) 831-7133
 Fax: (800) 284-4151
 Visit www.pentair.com

Technical Support
 Sanford, North Carolina (8 A.M. to 8.30 PM ET)
 Phone: (919) 566-8000
 Fax: (919) 566-8920
 Moorpark, California (8 A.M. to 5.30 PM PT)
 Phone: (805) 553-5000 (Ext. 5591)
 Fax: (805) 553-5515

Contents

IMPORTANT WARNING AND SAFETY INSTRUCTIONS **ii-vi**
OVERVIEW / SUMMARY **1-2**
BOX CONTENTS **3**
REMOVING THE EXISTING OUTDOOR CONTROL PANEL **4**
INSTALL THE NEW 4A AND 5A LOW VOLTAGE CIRCUIT BREAKERS AND SYSTEM TRANSFORMER **6-9**
INSTALLING THE INTELLICENTER CONTROL SYSTEM OUTDOOR CONTROL PANEL **10**
CONNECTING AND CONFIGURING POOL AND SPA EQUIPMENT **10**
INSTALLING THE WIRING LABEL ON THE ENCLOSURE FRONT DOOR **11**
Note: INSTALLING THE WIRELESS ANTENNA KIT.
(See IntelliCenter Control System Installation Guide).

General Installation Information

1. All work must be performed by a licensed electrician, and must conform to all national, state, and local codes.
2. Install to provide drainage of compartment for electrical components.
3. If this system is used to control underwater lighting fixtures, a ground-fault interrupter (GFCI) must be provided for these fixtures. Conductors on the load side of the ground-fault circuit-interrupter shall not occupy conduit, junction boxes or enclosures containing other conductors unless such conductors are also protected by a ground-fault circuit-interrupter. Refer to local codes for details.
4. A terminal bar stamped  is located inside the supply terminal box. To reduce the risk of electric shock, this terminal must be connected to the grounding means provided in the electric supply service panel with a continuous copper wire equivalent in size to the circuit conductors supplying this equipment (no smaller than 12 AWG or 3.3 mm). The bonding lug(s) provided on this unit are intended to connect a minimum of one No. 8 AWG for US installation and two No. 6 AWG for Canadian installations solid copper conductor between this unit and any metal equipment, metal enclosures or electrical equipment, metal water pipe, or conduit within 5 feet (1.5 m) of the unit.
5. The electrical supply for this product must include a suitably rated switch or circuit breaker to open all ungrounded supply conductors to comply with in accordance with the current National Electrical Code (NEC), NFPA 70 or the Canadian Electrical Code (CEC), CSA C22.1. All applicable local installation codes and ordinances must also be adhered to. The disconnecting means must be readily accessible to the tub occupant but installed at least 10 ft. (3.05 m) from the inside wall of the pool.
6. **GAS HEATER:** This automation control system is designed to supply high voltage (120 VAC / 240 VAC) to a gas heater and override the thermostat in the heater's control circuit. This automation control system is intended to control gas heaters with a high temperature limit switch(s) safety circuit.

IMPORTANT WARNING AND SAFETY INSTRUCTIONS

READ AND FOLLOW ALL WARNING AND SAFETY INSTRUCTIONS

⚠ DANGER SERIOUS BODILY INJURY OR DEATH CAN RESULT IF THIS PRODUCT (UNIT) IS NOT INSTALLED AND USED CORRECTLY.

⚠ DANGER INSTALLERS, POOL OPERATORS AND POOL OWNERS MUST READ THESE WARNINGS AND ALL INSTRUCTIONS BEFORE USING THIS PRODUCT. This Guide provides installation and operation instructions for the product. Consult Pentair Water Pool and Spa, Inc. (“Pentair”) with any questions regarding this product.

⚠ WARNING This product is intended for use in swimming pool applications only.

⚠ WARNING Most states and local codes regulate the construction, installation, and operation of public pools and spas, and the construction of residential pools and spas. It is important to comply with these codes, many of which directly regulate the installation and use of this product. Consult your local building and health codes for more information.



This guide provides installation and operation instructions for the IntelliCenter™ Control System. Consult Pentair Water Pool and Spa, Inc. with any questions regarding this equipment (see “Customer Service/Technical Support”, page ii).



Attention Installer: This guide contains important information about the installation, operation and safe usage of this product. Give this guide to the owner and/or operator of this equipment after installation.

Attention User: This manual contains important information that will help you in operating and maintaining this filter. Please save it for future reference.

⚠ WARNING **Attention User:** This Guide contains important information that will help you in operating and maintaining this product. Please retain it for future reference. Read the entire Installation Guide and all related warning labels before installing this product or attempting to use, service or adjust the IntelliCenter® Control System. Read the operating instructions and warnings for all equipment in the pool circulating system before operating. Failure to follow safety warnings and instructions can result in severe injury, death, or property damage. Call (800) 831-7133 for additional free copies of this Guide or replacement safety labels.

This product is designed and manufactured for safe and reliable service when installed, operated and maintained according to the information and installation codes referred to in this Guide.



This is a safety alert symbol. When you see this symbol in this manual or on the product, look for one of the following signal words; **DANGER, WARNING, CAUTION** and **NOTICE** and comply with the information. Be alert to the potential hazard. Ensure to read and comply with all of the warnings and cautions in this manual.

NOTICE



Risk of Electrical Shock or Electrocution!

⚠ DANGER



- Always disconnect power at the circuit breaker before servicing the load center. Improper installation can create an electrical shock hazard that can result in death or serious injury.

This product must be installed by a licensed or certified electrician or a qualified pool professional in accordance with the current National Electrical Code (NEC), NFPA 70 or the Canadian Electrical Code (CEC), CSA C22.1. All applicable local installation codes and ordinances must also be adhered to. Improper installation will create an electrical hazard which could result in death or serious injury to pool users, installers or others due to electrical shock, and may also cause damage to property. Always

disconnect the power to the pool light at the circuit breaker before servicing the light. Failure to do so could result in death or serious injury to serviceman, pool users or others due to electrical shock.

IMPORTANT WARNING AND SAFETY INSTRUCTIONS

⚠ DANGER



Water temperature in excess of 100° F (37.7° C) may be hazardous to your health. Prolonged immersion in hot water may induce hyperthermia. Hyperthermia occurs when the internal temperature of the body reaches a level several degrees above normal body temperature of 98.6° F (37° C.). Effects of hyperthermia include: (1) Unawareness of impending danger. (2) Failure to perceive heat. (3) Failure to recognize the need to leave the spa. (4) Physical inability to exit the spa. (5) Fetal damage in pregnant women. (6) Unconsciousness resulting in danger of drowning. The use of alcohol, drugs, or medication can greatly increase the risk of fatal hyperthermia in hot tubs and spas.

⚠ WARNING

A pool or spa pump must be installed by a qualified pool and spa service professional in accordance with the current National Electrical Code and all applicable local codes and ordinances. Improper installation may create an electrical hazard which could result in death or serious injury to pool users, installers, or others due to electrical shock, and may also cause damage to property.

⚠ WARNING

The use of alcohol, drugs, or medication can greatly increase the risk of fatal hyperthermia in hot tubs and spas. This product is intended to control heaters with built-in high limit circuits **ONLY**. Failure to do so may cause property damage or personal injury.

⚠ WARNING

Do not use this product to control an automatic pool cover. Swimmers may become entrapped underneath the cover.

⚠ WARNING

For units intended for use in other than single-family dwellings, a clearly labeled emergency switch shall be provided as part of the installation. The switch shall be readily accessible to the occupants and shall be installed at least five (5) feet (1.52 m) away, adjacent to, and within sight of, the unit.

⚠ WARNING

Except for listed spa-side remote controls, install a minimum of five (5) feet (1.52 m) from the inside wall of the pool and spa.

⚠ WARNING

The electrical supply for this product must include a suitably rated switch or circuit breaker to open all ungrounded supply conductors to comply with the current National Electrical Code (NEC), NFPA 70 or the Canadian Electrical Code (CEC), CSA C22.1. All applicable local installation codes and ordinances must also be adhered to. The disconnecting means must be readily accessible to the tub occupant but installed at least five 5ft. (1.52 m), (Canada 3 m (9.75 ft) from the inside wall of the pool.

⚠ WARNING

Use only copper supply conductor's rated for 60C/75C sized based on ampacity to support all loads (refer to NEC tables). Load center input supply to be protected by 150 Amp Maximum, 240 VAC Main Circuit Breaker.

For information about the Virginia Graeme Baker Pool and Spa Safety Act, contact the Consumer Product Safety Commission at (301) 504-7908 or visit www.cpsc.gov.

NOTE: Always turn off all power to the pool pump before installing the cover or working on any suction outlet.

Two Speed Pump Controls Notice (Title 20 Compliance)

Please read the following important Safety Instructions - When using two-speed pumps manufactured on or after January 1, 2008, the pump's default circulation speed **MUST** be set to the **LOWEST SPEED**, with a high speed override capability being for a temporary period not to exceed one normal cycle, or two hours, whichever is less.

IMPORTANT WARNING AND SAFETY INSTRUCTIONS



FCC Regulatory Safety Notice

FCC non-modification statement:

Changes or modifications not expressly approved by the party responsible for compliance could void the user's authority to operate the equipment.

FCC RF Exposure requirements:

FCC Standard - 47 CFR Part 15, Subpart C (Section 15.247). This version is limited to chapter 1 to chapter 11 by specified firmware controlled in the U.S.A.

Notice: In order to comply with FCC RF Exposure requirements, a minimum separation distance of 8 in (20 cm) must be maintained between the equipment and all persons during normal operation.

Instruction to user - The IntelliCenter™ Control System device has been tested and found to comply with the limits for a Class B digital device, pursuant to Part 15 of the FCC Rules. These limits are designed to provide reasonable protection against harmful interference in a residential installation. The IntelliCenter Control System generates, uses and can radiate radio frequency energy and, if not installed and used in accordance with the instructions, may cause harmful interference to radio communications. However, there is no guarantee that interference will not occur in a particular installation. If this device does cause harmful interference to radio or television reception, which can be determined by switching the device off and on, the user is encouraged to try to correct the interference by one or more of the following measures:

- Reorient or relocate the receiving antenna.
- Increase the separation between the equipment and receiver.
- Connect the equipment into an outlet on a circuit different from that to which the receiver is connected.
- Consult the dealer or an experienced radio/TV technician for help.

Note: The user is cautioned that changes and modifications made to the IntelliCenter Control System without the approval of the manufacturer could void the user's authority to operate this equipment.

Industry Canada (IC) Regulatory Notice – RSS210:

Instruction To User: This device complies with RSS210 of Innovation, Science and Economic Development Canada (ISED). Under ISED regulations, this radio transmitter may only operate using an antenna of a type and maximum (or lesser) gain approved for the transmitter by ISED. To reduce potential radio interference to other users, the antenna type and its gain should be so chosen that the equivalent isotropically radiated power (e.i.r.p.) is not more than that necessary for successful communication. This device complies with Innovation, Science and Economic Development Canada licence-exempt RSS standard(s). Operation is subject to the following two conditions: (1) this device may not cause interference, and (2) this device must accept any interference, including interference that may cause undesired operation of the device.

Conformément à la réglementation d'Innovation, Sciences et Développement Économique Canada (ISED), le présent émetteur radio peut fonctionner avec une antenne d'un type et d'un gain maximal (ou inférieur) approuvé pour l'émetteur par ISED. Dans le but de réduire les risques de brouillage radioélectrique à l'intention des autres utilisateurs, il faut choisir le type d'antenne et son gain

Canada - Industry Canada (IC) - The IntelliCenter Control System complies with RSS210 of Industry Canada. (1999). Operation is subject to the following two conditions: (1) this device may not cause interference, and (2) this device must accept any interference, including interference that may cause undesired operation of the device.

The device complies with industry Canada's License Exempt RSSs. Operation is subject to the following: (1) This device may not cause interference; and (2) This device must accept interference that may cause undesired operation of the device.

Le dispositif est conforme à la licence d'Industrie Canada Exempt CNR. Le fonctionnement est soumis à la suivante.

(1) Ce ne doit pas provoquer d'interférences ; et (2) Cet appareil doit accepter les interférences qui peuvent causer un mauvais fonctionnement de l'appareil.

This Class B digital apparatus complies with Canadian ICES-003. Cet appareil numérique de la classe B est conforme à la norme NMB-003 du Canada. The term "IC" before the certification / registration number only signifies that the Industry Canada technical specifications were met.

Pentair Water Pool and Spa IMPORTANT SAFETY INSTRUCTIONS

For Installation of Electrical Controls at Equipment Pad (ON/OFF Switches, Timers, and Automation Control Systems)

WARNING



Install all electrical controls at equipment pad, such as on/off switches, timers, and control systems, etc. to allow the operation (start-up, shut-down, or servicing) of any pump or filter so the user does not place any portion of his/her body over or near the pump strainer lid, filter lid or valve closures. This installation should allow the user enough space to stand clear of the filter and pump during system start-up, shut down or servicing of the system filter.

CAUTION

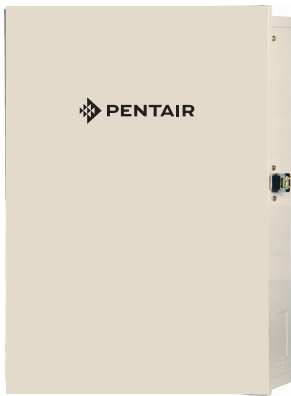

CAUTION! INSTALL POWER CENTER TO ALLOW USER ENOUGH SPACE TO STAND CLEAR OF PUMP AND FILTER WHEN SERVICING.

WARNING

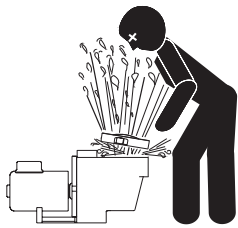

HAZARDOUS PRESSURE: STAND CLEAR OF PUMP AND FILTER DURING START-UP

Qualifications for Installers and Users

This product must be installed by a qualified pool technician in accordance with all applicable local codes and ordinances. It must be serviced by someone who fully understands its operation. Improper installation or servicing could result in death or serious injury to pool users, installers, servicers, or others and may also cause damage to property.

If you are not familiar with your pool filtering system and/or heater, do NOT attempt to adjust or service without consulting your dealer or a qualified pool technician.

Do not permit children to use this product.

EasyTouch® and IntelliTouch® Control System Upgrade Installation Kits

Overview

This manual describes how to upgrade an EasyTouch or IntelliTouch Control System to the IntelliCenter® Control System.

The Upgrade Installation Kits apply to the following:

- EasyTouch® PL4/PSL4 Control Systems, EasyTouch® Control Systems
- IntelliTouch® Control Systems

Systems using the following Load Center or Power Center use the following kit part numbers:

- 2012 or newer (square low voltage circuit breaker configuration)
 - P/N 522047 for i10P
 - P/N 522048 for i10PS
 - P/N 523049 for i10D
 - P/N 523529 for i10X

IntelliCenter Control System Outdoor Control Panel

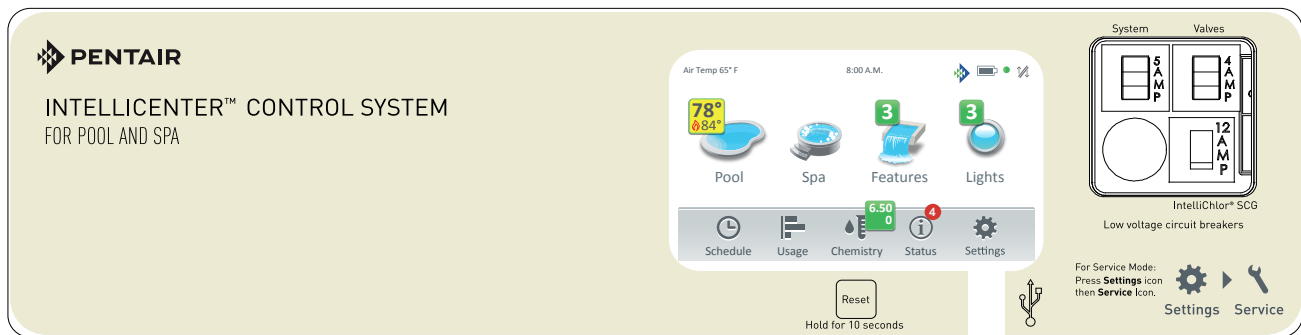

IntelliCenter Control System Outdoor Control Panel for EasyTouch or IntelliTouch Load Center or Power Center

IntelliCenter® Control System Installation Instructions Summary

REMOVING THE EXISTING OUTDOOR CONTROL PANEL	4
INSTALL THE NEW 4A AND 5A LOW VOLTAGE CIRCUIT BREAKERS AND SYSTEM TRANSFORMER	6-9
INSTALLING THE INTELLICENTER CONTROL SYSTEM OUTDOOR CONTROL PANEL.....	10
CONNECTING AND CONFIGURING POOL AND SPA EQUIPMENT	10
INSTALLING THE WIRING LABEL ON THE ENCLOSURE FRONT DOOR	11

Note: INSTALLING THE WIRELESS ANTENNA KIT. See IntelliCenter Control System Installation Guide.

CAUTION: If there are EasyTouch or IntelliTouch Control System installed accessories, such as an Indoor Control Panel or Wireless Remote, they will no longer function after installing the IntelliCenter Control System Upgrade Kit. In addition to the free IntelliCenter Control System phone app, the following optional accessories can also be purchased.

- IntelliCenter Indoor Control Panel, White Faceplate - P/N 522035
- IntelliCenter Indoor Control Panel, Tan Faceplate - P/N 523058.
- IntelliCenter Indoor Control Panel, Black Faceplate - P/N 523059.
- IntelliCenter Wireless Remote with Transceiver -P/N 522036.

Required Tools:

- Medium size flat blade screwdriver or 1/4" and 5/16" sockets
- Needle nose pliers

Removing the Existing Outdoor Control Panel

The following upgrade installation instructions are for **EasyTouch® PL4/PSL4, EasyTouch or IntelliTouch® Control Systems** using the 2012 or later (square low voltage circuit breakers configuration on bezel) Load Center or Power Center.

WARNING!
RISK OF ELECTRICAL SHOCK. BEFORE REMOVING THE HIGH VOLTAGE COVER PANEL FROM THE ENCLOSURE SWITCH OFF THE MAIN POWER AT THE HOME AT THE MAIN CIRCUIT BREAKER BOX.

1. TURN OFF POWER TO ALL POOL AND SPA EQUIPMENT BEFORE STARTING. CAUTION! DO NOT PLUG IN OR UNPLUG ANY SYSTEM COMPONENTS WITH THE POWER ON. THIS MAY DAMAGE THE SYSTEM COMPONENTS.
2. Unlatch the front door latch. Open the door of the Load Center or Power Center.
3. Remove the two screws securing the High Voltage Cover Panel. Remove the panel and set aside.
4. Loosen the two retaining screws securing the existing control panel. Fold down the panel to access the circuit board low voltage connections and transformer connector.

Continue to next page

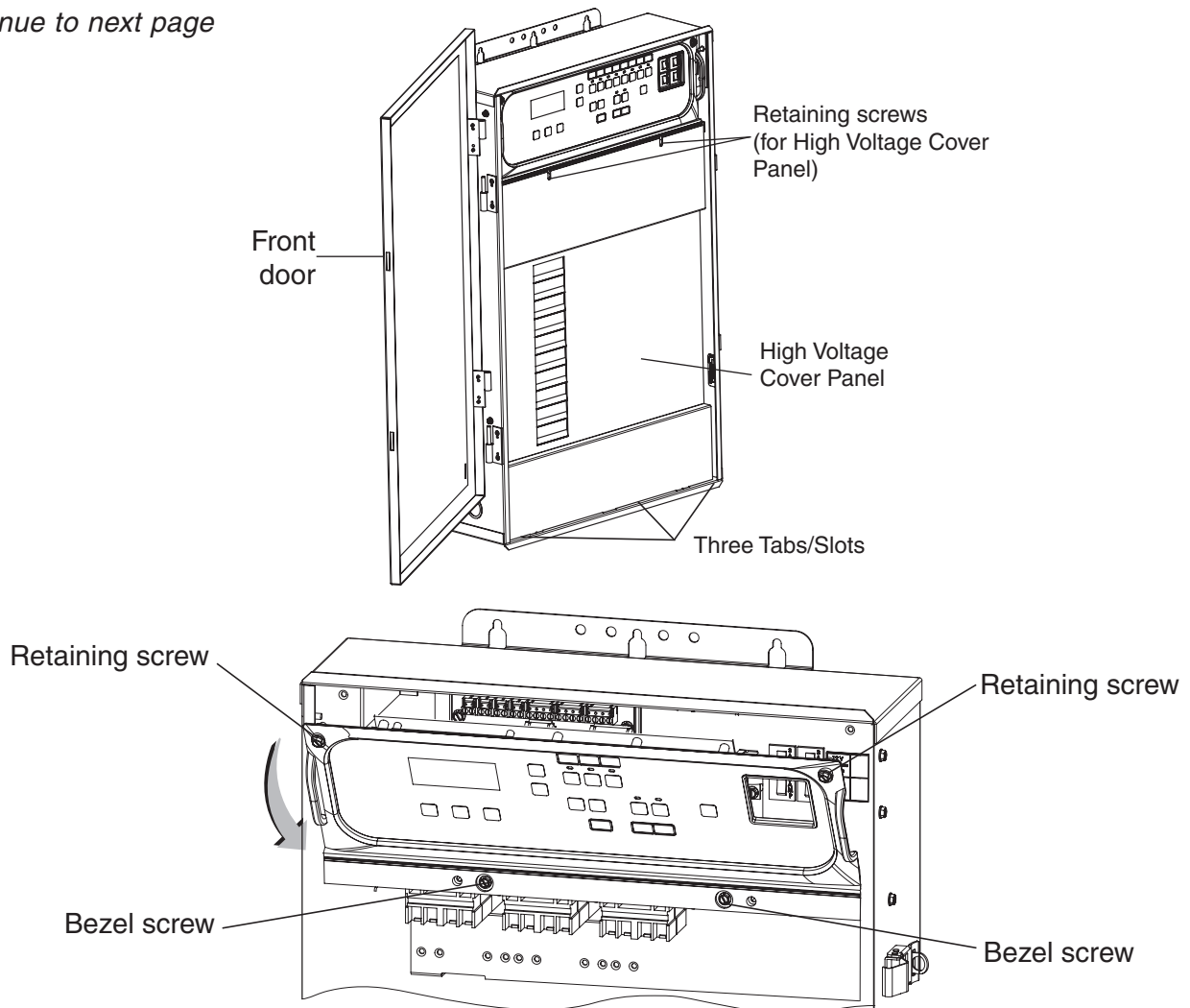

Figure 2. Load Center or Power Center (2012 or later)

Removing the Existing Outdoor Control Panel (Continued)

5. Disconnect the transformer connector and if necessary the SCG Board connector (RS-485) from the existing Outdoor Control Panel circuit board.
6. Disconnect all other connections from the circuit board.

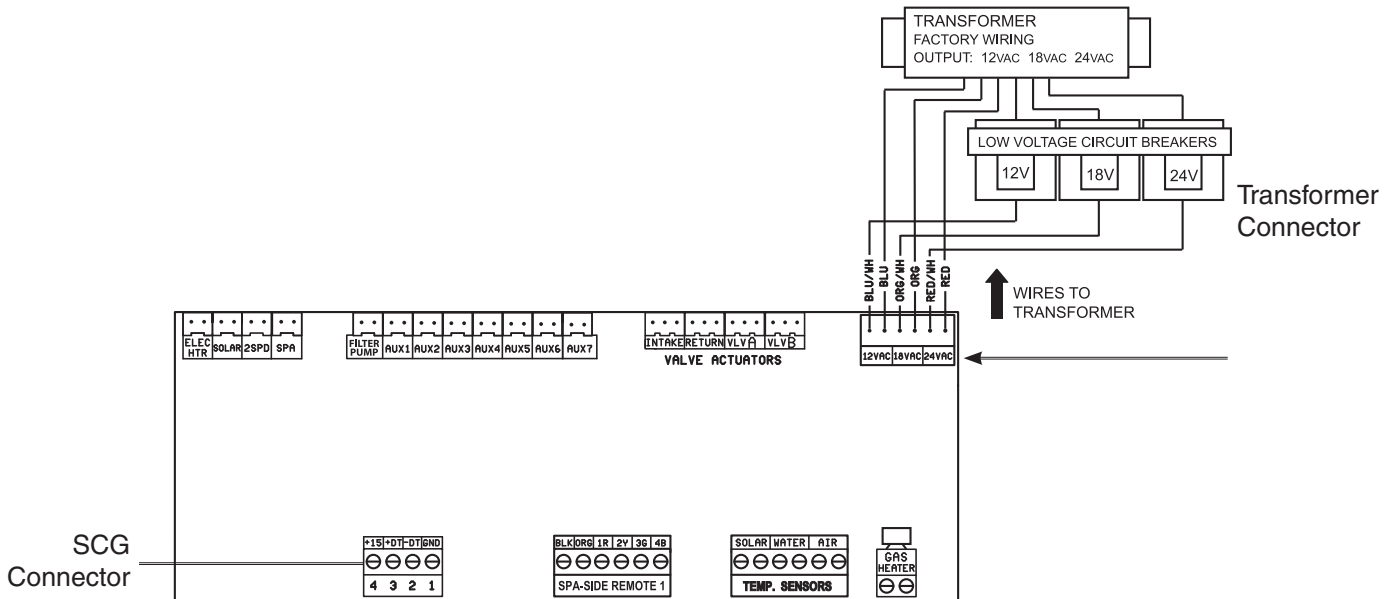

Figure 3. Transformer Connector and SCG Board Connector

7. Remove the two screws securing the outdoor control panel bezel. Remove the outdoor control panel and bezel from the enclosure. See Figure 2 on page 4.

Install the new 4A and 5A Low Voltage Circuit Breakers and System Transformer

Remove the existing 3/4 AMP circuit breakers from circuit breaker bracket: See Figure 4 below.

1. **Remove bracket screws to access the circuit breakers:** Remove the two side screws on the side of the enclosure, and the screw on the back of the enclosure securing the circuit breaker bracket with the SCG ground wire if present.
2. Disconnect both connectors from the rear of each circuit breaker, except for the 12 A SCG breaker if present.
3. From the rear of the circuit breaker, using needle nose pliers, press the side tabs and slide the circuit breaker out of the front of the bracket. Remove the circuit breakers from the bracket.

Install the IntelliCenter Control System 5AMP (P/N 522339) and 4 AMP (P/N 522338) circuit breakers: See Figure 5 on page 7

4. Insert the 5A circuit breaker (3b) into the front of the bracket (first opening on the left side front view) and snap in place. Be sure to orient the 5A marking in the upright position.
5. Insert the 4A circuit breaker (3a) into the front of the bracket (next to the 5A circuit breaker) and snap in place. Be sure to orient the 4A marking in the upright position.
6. Insert the circuit breaker plug (4) (P/N 521090) into the bracket opening under the 5A breaker.
7. Place the new circuit breaker label (5) (P/N 522337) over the existing label on the front of the bracket.

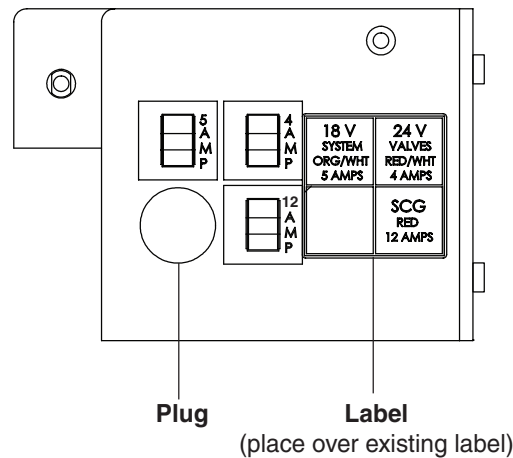

Figure 4. Circuit Breakers Wiring

Install the new 4A and 5A Low Voltage Circuit Breakers and System Transformer Continued

Wiring the new System Transformer (P/N 522102)

The IntelliCenter® Control System Load Center or Power Center System Transformer can be wired for 120VAC, 2.5A, 240VAC, 1.3A, 50/60 Hz.

1. **Remove the existing System Transformer:** Remove the four screws securing the transformer to the enclosure. Discard the existing system transformer.
2. **Wiring the Low Voltage Transformer:** Mount the new transformer (6) (P/N 522102) onto the back wall of the enclosure. Secure it with the four screws (7) (P/N 520222, provided in kit). See Figure 6. Route the transformer (and Circuit breakers) secondary wires through channel opening up to the circuit breaker bracket.
3. **Connect Circuit Breaker Wires:** Connect both Orange/White wires from the System Transformer Orange/White to the 5A circuit breaker terminal, and both Red/White wires to the 4A circuit breaker terminal. See Figure 5.

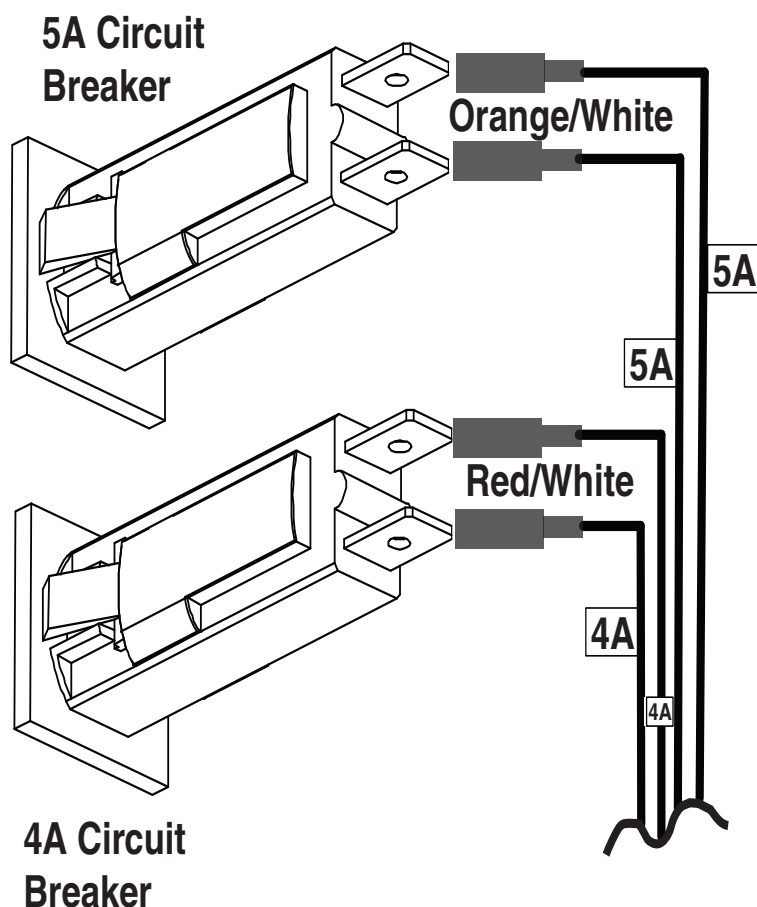

Figure 5. Circuit Breakers Transformer Connections

4. **Reconnect 120 VAC Transformer Wires:** Reconnect the System Transformer wires (see wiring diagram below) to the Load Center (or Power Center) circuit breaker.

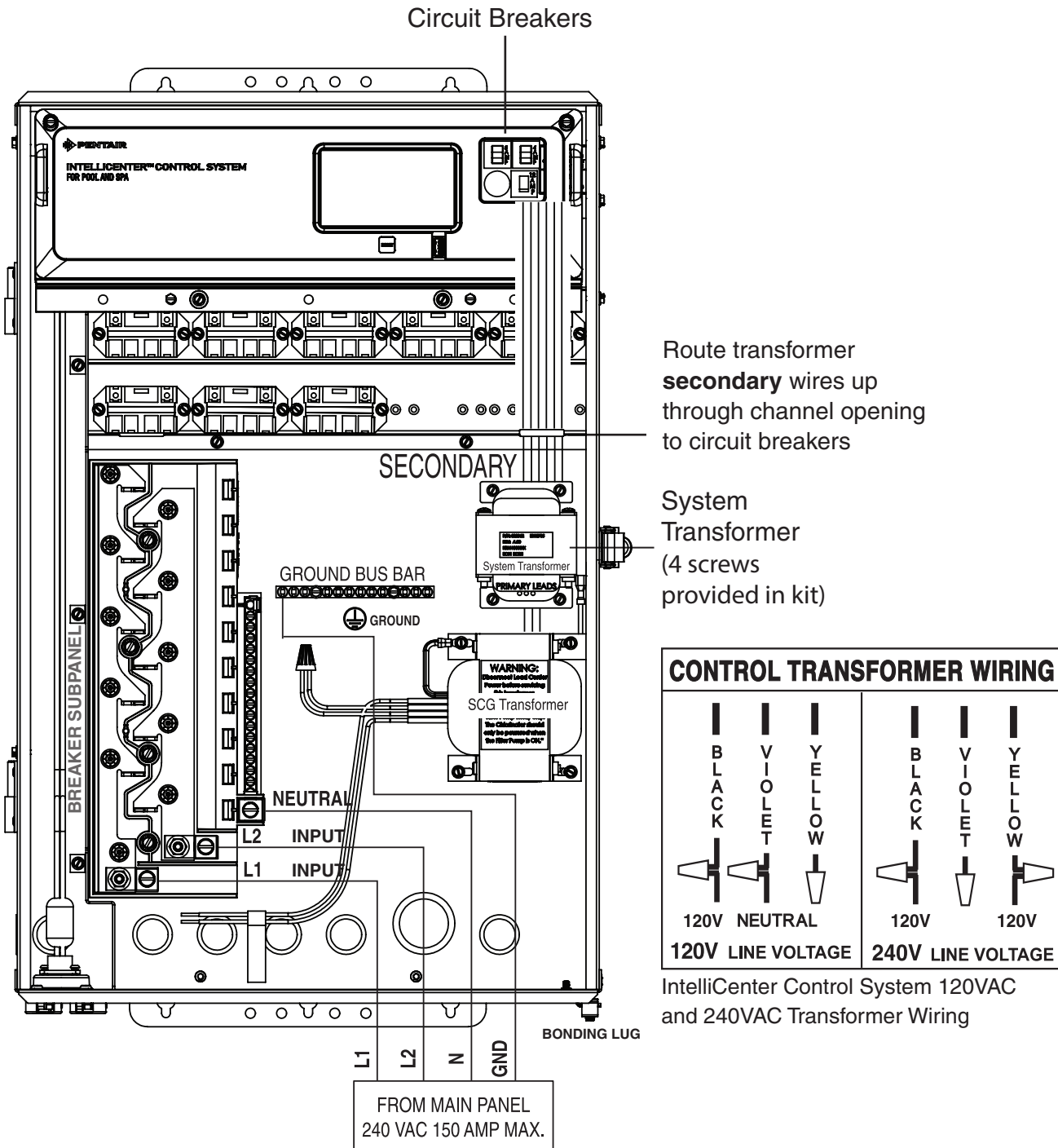

Figure 6. Wiring the System Transformer (Load Center or Power Center 2012 or later)

Note: Refer to page 3 where (parts index number) is shown

5. Install the circuit breaker bracket with the circuit breakers onto the enclosure, and secure it with two #8-32 x 3/8" screws (7).
6. Secure the circuit breaker bracket onto the back of the enclosure with #8-32 x 3/8" screw. Be sure to reinstall the SCG ground wire (if present). See Figure 7.

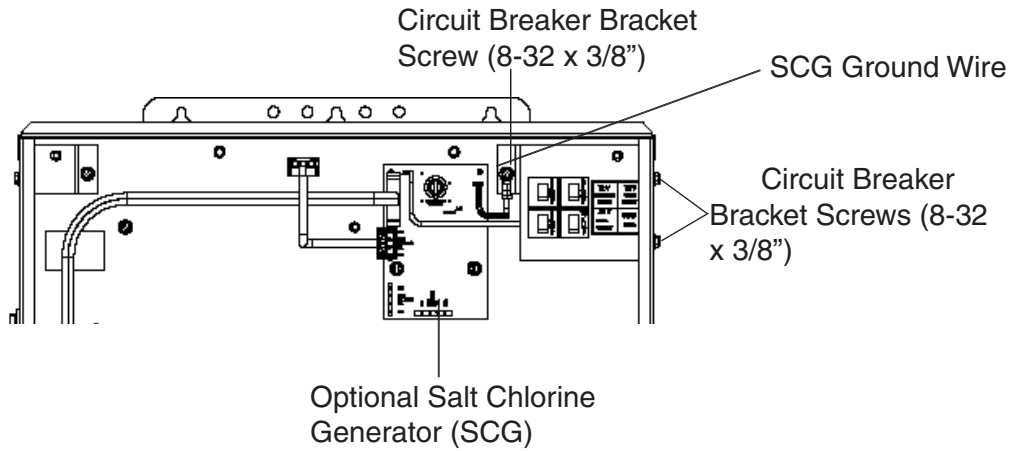

Figure 7. Circuit Breakers Bracket

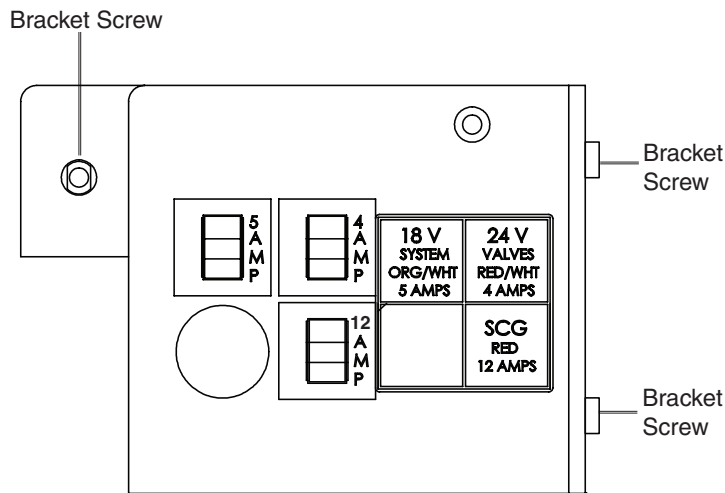

Figure 8. Circuit Breaker Bracket Screws

Installing the IntelliCenter® Control System Outdoor Control Panel

1. **Install the IntelliCenter Outdoor Control Panel (1) and Bezel:** Mount the Outdoor Control Panel and bezel onto the enclosure. Install the two screws to secure the bezel to the enclosure.
2. Connect the Transformer plug to the IntelliCenter Control System main motherboard (See Figure 9).
3. Reconnect all of the low voltage connections on the main circuit board.
4. If necessary connect the IntelliChlor® SCG wires to COM Port J4. See Figure 11, page 11 for wiring diagram.
5. Secure the control panel bezel to the enclosure with the two retaining screws. See Figure 10.

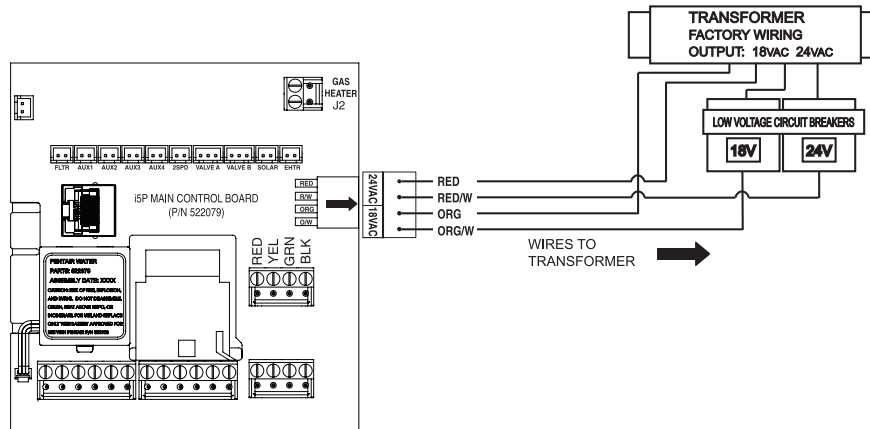

Figure 9. Wiring the System Transformer and Circuit Breakers (Load Center or Power center 2012 or later)

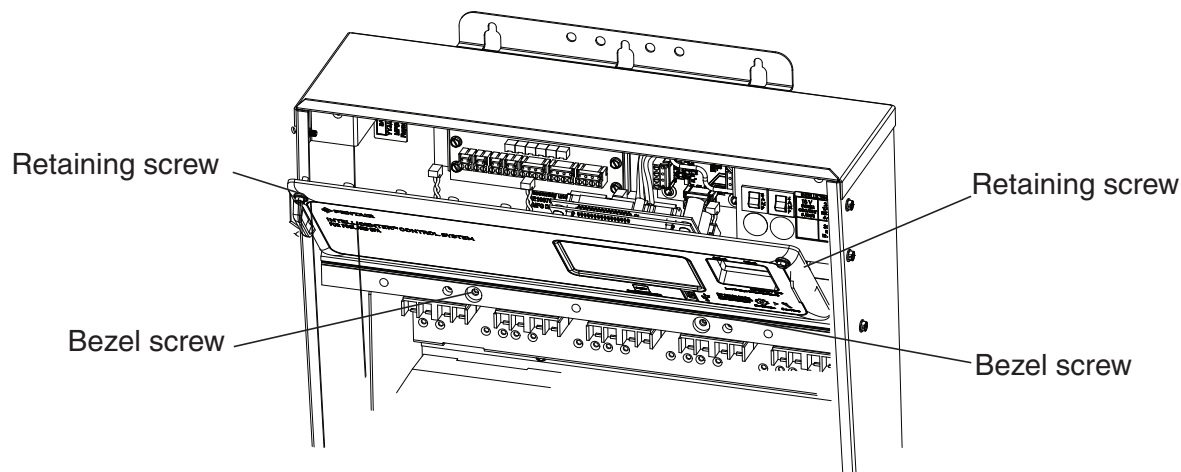

Figure 10. IntelliCenter Control System Outdoor Control Panel

Connecting and configuring pool and spa equipment (Figure 11 on next page)

Please refer to the IntelliCenter Control System Installation Guide (P/N 522989) and the IntelliCenter Control System User's Guide (522990) for the following information:

- **Connecting the system transformer (and SCG transformer option if installed) to the IntelliCenter Outdoor Control Panel main circuit board**
 - **Connecting low voltage pool and spa equipment (pump, heater, spa side remote etc.) to the IntelliCenter Outdoor Control Panel main circuit board**
1. After all electrical connections have been completed, close the Outdoor Control Panel and tighten the two retaining screws. **Reinstall the High Voltage Panel:** Insert the panel's three tabs into the lower slots on the enclosure. Secure the panel with the two retaining screws. See Figure 2 on page 4.

Note: Refer to page 3 where (parts index number) is shown

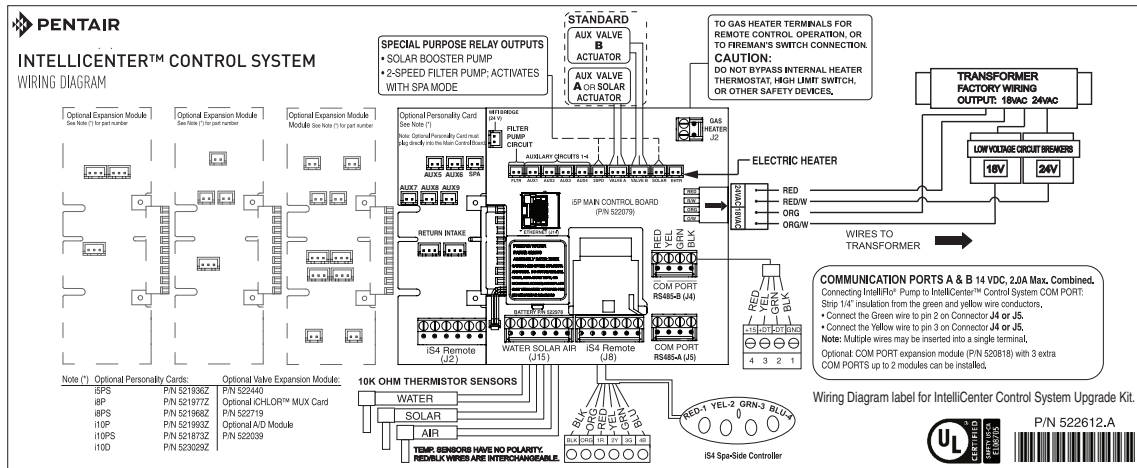

Figure 11. IntelliCenter™ Control System Circuit Board (with optional Expansion Boards shown)

Installing the Wiring Label on the Enclosure Front Door

1. Remove the backing from the wiring label.
2. Affix the wiring label ((10), P/N 522612) onto High Voltage Cover panel. See Figure 12.
3. Close the front door and secure with the latch.
4. Switch ON AC POWER to the load center at the circuit breaker.

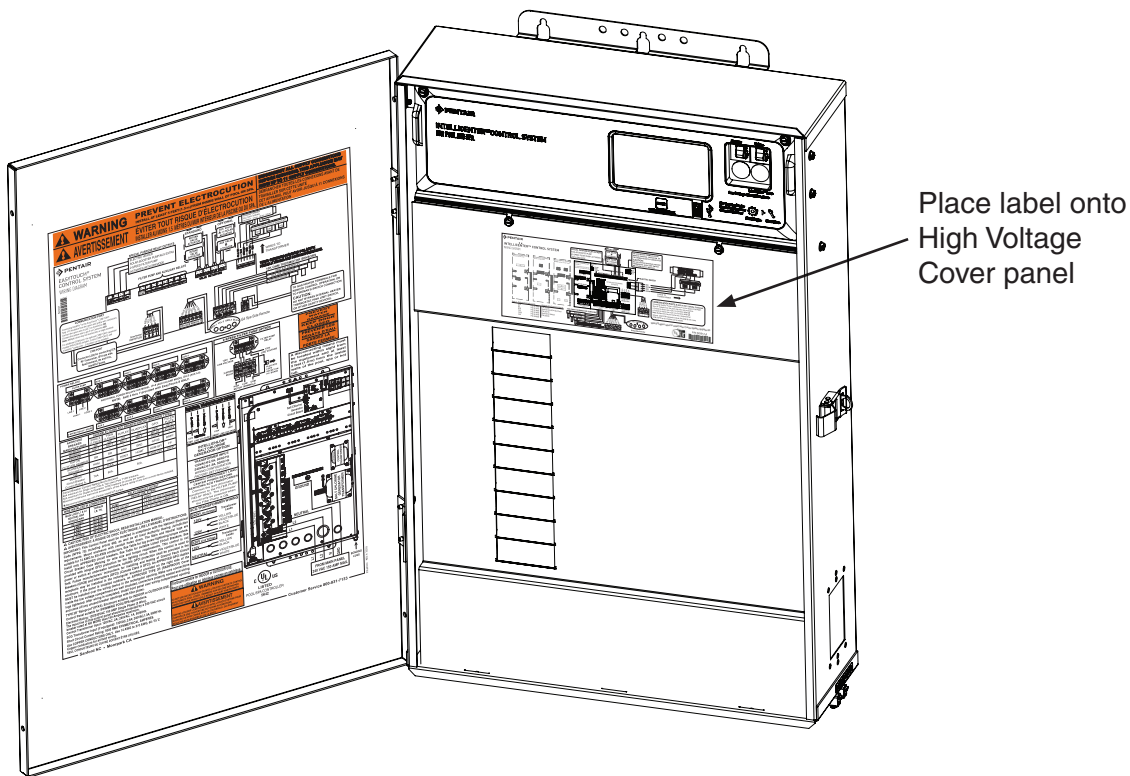

Figure 12. Load Center shown (2012 or later)

NOTES

NOTES



1620 HAWKINS AVE., SANFORD, NC 27330 • (919) 566-8000
10951 WEST LOS ANGELES AVE., MOORPARK, CA 93021 • (805) 553-5000

All indicated Pentair trademarks and logos are property of Pentair. Third party registered and unregistered trademarks and logos are the property of their respective owners

© 2024 Pentair. All rights reserved. WWW.PENTAIR.COM



P/N 523455 Rev. E 1/22/24