

# Autotrol Performa 263-268 Easy-iQ



## IMPORTANT SAFETY INSTRUCTIONS

Read and follow all instructions  
Save these instructions

[WWW.PENTAIR.EU/](http://WWW.PENTAIR.EU/)  
[WWW.PENTAIR.COM\(NAM\)](http://WWW.PENTAIR.COM(NAM))

## Table of Contents

<b>1</b>	<b>Generalities .....</b>	<b>6</b>
1.1	Scope of the documentation .....	6
1.2	Release management .....	6
1.3	Manufacturer identifier, product identification .....	6
1.4	Abbreviations used.....	7
1.5	Norms.....	7
1.5.1	Applicable norms .....	7
1.5.2	Available certificates.....	8
1.6	Procedure for technical support .....	8
1.7	Copyright and Trademarks .....	9
1.8	Limitation of liability .....	9
1.9	Pentair Scan application (For Europe exclusively).....	10
<b>2</b>	<b>Safety.....</b>	<b>11</b>
2.1	Safety pictograms definition .....	11
2.2	Serial label location .....	12
2.3	Hazards .....	12
2.3.1	Personnel .....	13
2.3.2	Material .....	13
2.4	Hygiene and sanitization .....	13
2.4.1	Sanitary issues .....	13
2.4.2	Hygiene measures .....	14
<b>3</b>	<b>Description .....</b>	<b>15</b>
3.1	Technical specifications.....	15
3.2	Performance flow rate characteristics .....	16
3.3	Outline drawing.....	17
3.4	Components description and location .....	18
3.5	Options available on the valve .....	19
3.5.1	Valve Camshaft (Black) .....	19
3.5.2	Blending valve kit .....	21
3.6	Softener operating mode (8-cycles operation).....	22
3.7	Filter operating mode (3-cycles operation).....	24
<b>4</b>	<b>System sizing.....</b>	<b>26</b>
4.1	Softener configuration (Performa 268) .....	26
4.1.1	Default Injector/DLFC/Refill flow controller - Valve configuration .....	26
4.2	Filter configuration (Performa 263).....	26
4.3	Cycle time calculation.....	26

4.4	Salt dosage definition.....	27
4.5	Injector flow rates.....	30
<b>5</b>	<b>Installation .....</b>	<b>32</b>
5.1	Product identification.....	32
5.2	Safety notices for installation .....	32
5.3	Installation environment.....	33
5.3.1	General.....	33
5.3.2	Water .....	33
5.3.3	Electrical .....	34
5.3.4	Mechanical .....	34
5.3.5	Outdoor Locations.....	35
5.4	Integration constraints .....	36
5.5	Block diagram and configuration example .....	37
5.6	Valve on tank assembly .....	38
5.7	Valve connection to piping .....	38
5.7.1	Top-mounted valve installation .....	39
5.8	Regeneration mode.....	41
5.9	Electrical connection .....	42
5.10	Bypassing.....	42
5.11	Drain line connection .....	43
5.12	Overflow line connection.....	44
5.13	Brine line connection (Performa 268 - Softener configuration only) .....	45
<b>6</b>	<b>Programming .....</b>	<b>46</b>
6.1	Display.....	46
6.2	Program structure and navigation .....	47
6.2.1	USB menu structure .....	48
6.2.2	Quick Start-up menu structure and navigation.....	49
6.2.3	Service menu structure and navigation.....	50
6.2.4	Settings menu structure and navigation .....	51
6.2.5	Diagnostics menu structure and navigation.....	53
6.2.6	Manual regeneration menu structure and navigation .....	54
6.3	Parameter setting .....	55
6.4	USB configuration and update.....	56
6.5	Quick Start-up setup.....	57
6.5.1	Quick Start-up mode programming chart.....	57
6.5.2	Language.....	58
6.5.3	Valve type .....	58
6.5.4	Unit of measure.....	59
6.5.5	Hardness unit .....	59
6.5.6	Hardness .....	60
6.5.7	Resin volume.....	60

6.5.8	Salt dosage .....	60
6.5.9	Time.....	61
6.5.10	Date .....	61
6.5.11	Quick Start-up completed.....	62
<b>6.6</b>	<b>Settings menu .....</b>	<b>62</b>
6.6.1	Submenu selection .....	62
6.6.2	Alert setting menu .....	63
6.6.3	User setting menu.....	64
6.6.4	Diagnostic menu .....	70
6.6.5	Installer setting menu.....	71
6.6.6	Cycle time setting menu .....	80
6.6.7	PIN setting menu .....	82
6.6.8	OEM setting menu.....	85
6.6.9	Reset menu .....	89
<b>6.7</b>	<b>Diagnostic menu .....</b>	<b>91</b>
6.7.1	Diagnostic menu access .....	91
6.7.2	Data submenu selection .....	91
6.7.3	Error log submenu.....	92
6.7.4	Regeneration information.....	92
6.7.5	Water usage history .....	93
6.7.6	Status .....	94
<b>7</b>	<b>Commissioning .....</b>	<b>96</b>
7.1	Air purge, water filling and waterproofness inspection.....	96
7.1.1	Starting-up the water softener .....	96
7.1.2	Additional tips.....	98
7.2	Sanitization.....	98
7.2.1	Disinfection of water softeners.....	98
7.2.2	Sodium or calcium hypochlorite .....	99
<b>8</b>	<b>Operation.....</b>	<b>100</b>
8.1	Display .....	100
8.1.1	Operation display color .....	100
8.1.2	During service .....	100
8.1.3	During regeneration.....	101
8.2	Recommendations .....	101
8.3	Manual regeneration .....	101
8.3.1	Trigger an immediate or delayed regeneration .....	102
8.3.2	To advance regeneration cycles .....	102
8.3.3	To cancel a regeneration .....	102
8.4	Operation during a power failure .....	103
<b>9</b>	<b>Maintenance .....</b>	<b>104</b>
9.1	General system inspection .....	104
9.1.1	Performa 263 .....	104
9.1.2	Performa 268 .....	105
9.2	Recommended maintenance plan.....	106



9.2.1	Performa 263 .....	106
9.2.2	Performa 268 .....	107
9.3	Recommendations .....	108
9.3.1	Use original spare parts .....	108
9.3.2	Use original approved lubricants.....	108
9.3.3	Maintenance instructions .....	108
9.4	Cleaning and maintenance .....	109
9.4.1	First steps .....	109
9.4.2	Firmware update.....	109
9.4.3	Injector cleaning.....	109
9.4.4	Refill controller cleaning .....	109
9.4.5	Injector screen cleaning .....	111
9.4.6	Backwash controller cleaning .....	111
9.4.7	Valve cover disassembly.....	112
9.4.8	Motor and camshaft replacement .....	113
9.4.9	Optical sensor and controller replacement .....	114
9.4.10	Turbine cleaning or replacement .....	115
9.4.11	Top plate, flapper spring and flappers replacement .....	116
<b>10</b>	<b>Troubleshooting .....</b>	<b>118</b>
10.1	Error display color .....	118
10.2	Easy-iQ controller .....	118
10.3	Valve .....	119
<b>11</b>	<b>Spare parts .....</b>	<b>122</b>
11.1	Valve parts list.....	122
11.2	Easy-iQ Controller and power supply.....	124
11.3	1265 Bypass & Connections.....	125
11.4	Valve installation kits .....	126
11.4.1	Performa 263 .....	126
11.4.2	Performa 268 .....	127
<b>12</b>	<b>Disposal .....</b>	<b>128</b>

# 1 Generalities

## 1.1 Scope of the documentation

The documentation provides the necessary information for appropriate use of the product. It informs the user to ensure efficient execution of the installation, operation or maintenance procedures.

The content of this document is based on the information available at the time of publication. The original version of the document was written in English.

For safety and environmental protection reasons, the safety instructions given in this documentation must be strictly followed.

The manufacturer reserves the right to make changes at any time without notice.

This manual is a reference and will not include every system installation situation. The person installing this equipment should have:

- training in the Autotrol series, Easy-iQ controllers and water treatment appliances installation;
- knowledge of water conditioning and how to determine proper controller settings;
- basic plumbing skills.

This document is available in other languages on <https://www.pentair.eu/product-finder/product-type/control-valves>.

## 1.2 Release management

Revision	Date	Authors	Description
A	13.06.2024	BRY/FLA	First edition.

## 1.3 Manufacturer identifier, product identification

Manufacturer: Pentair International SARL  
 Voie du chariot 3  
 1003 Lausanne  
 Switzerland  
**US legal entity**  
 Pentair  
 13845 Bishops Drive Suite 200  
 Brookfield, WI. USA 530035

Assembled in the factory: Pentair Manufacturing Italy  
Via Masaccio 13  
Lugnano di Vicopisano 56010 (PI),  
Italy

Product identification: Autotrol Performa 263-268 Easy-iQ

## 1.4 Abbreviations used

Assy	Assembly
BLFC	Brine Line Flow Controller
BV	Brine Valve
CW	Cold Water
DF	Down Flow
Dist.	Distribution
DLFC	Drain Line Flow Controller
HiEF	High Efficiency
HW	Hot Water
Inj	Injector
N/A	Not Available
NBP	No By Pass
PN	Part Number
QC	Quick Connect
Regen	Regeneration
S&S	Seal & Spacer
SBV	Safety Brine Valve
Sis	System
SM	Side Mounted
STD	Standard
TC	Time Clock
TM	Top Mounted
UF	Up Flow
VB	Valve Body

## 1.5 Norms

### 1.5.1 Applicable norms

#### Applicable norms for Europe

Comply with the following guidelines:

- 2014/35/UE: Low Voltage Directive;

- 2014/30/UE: Electromagnetic compatibility;
- 2011/65/UE: Restriction of use of certain hazardous substances in electrical and electronic equipment (RoHS);
- Regulation CE 1908/2006: concerning the registration, evaluation, authorization and restriction of chemical substances (REACH);
- UNI EN ISO9001.

Meets the following technical standards:

- EN IEC 60335-1;
- EN IEC 61010-1;
- CISPR 14-1;
- CISPR 14-2;
- EN IEC 61326-1;

### **Applicable norms for North America**

Comply with the following guidelines:

- UL 979 ;
- NSF/ANSI Standard 44 ;
- CSA B483.1 ;
- FCC 47 CFR part 15 subpart b and C;
- ISED-ICES-003;
- ISED-RSS-210.

### **1.5.2 Available certificates**

#### **For Europe**

- CE;
- DM174;
- ACS.

Please find beside the certifications for some of our product families. Please note that this list is not an exhaustive list of all our certifications. In case of need for more information please contact us.



#### **For North America**

- UL;
- WQA;
- FCC;
- ISED.

## **1.6 Procedure for technical support**

Procedure to follow for any technical support request:

1. Collect the required information for a technical assistance request.

- ⇒ Product identification [see Serial label location [→Page 12] and Recommendations [→Page 108]];
  - ⇒ Description of the device problem.
2. Please refer to the Troubleshooting [→Page 118]. If the problem persists contact your supplier.

Europe: **techsupport.water@pentair.com**

NAM: Phone: 1-800-279-9404

**tech-support@pentair.com**

## 1.7 Copyright and Trademarks

All indicated Pentair trademarks and logos are property of Pentair. Third party registered and unregistered trademarks and logos are the property of their respective owners.

© 2023 Pentair. All rights reserved.

## 1.8 Limitation of liability

Pentair Water Treatment EMEA products benefit, under specific conditions, from a manufacturer warranty that may be invoked by Pentair's direct customers. Users should contact the vendor of this product for applicable conditions and in case of a potential warranty claim.

Any warranty provided by Pentair regarding the product will become invalid in case of:

- installation done by a non-water-professional;
- improper installation, improper programming, improper use, improper operation and/or maintenance leading to any kind of product damages;
- improper or unauthorized intervention on the controller or components;
- incorrect, improper or wrong connection/assembly of systems or products with this product and vice versa;
- use of a non-compatible lubricant, grease or chemicals of any type and not listed by the manufacturer as compatible for the product;
- failure due to wrong configuration and/or sizing.

Pentair accepts no liability for equipment installed by the user upstream or downstream of Pentair products, as well as for process/production processes which are installed and connected around or even related to the installation. Disturbances, failures, direct or indirect damages that are caused by such equipment or processes are also excluded from the warranty. Pentair shall not accept any liability for any loss or damage to profits, revenues, use, production, or contracts, or for any indirect, special or consequential loss or damage whatsoever. Please refer to the Pentair List Price for more information about terms and conditions applicable to this product.

## 1.9 Pentair Scan application (For Europe exclusively)

Pentair Scan mobile application is the ideal support for the maintenance person in his daily business. A simple scan of the serial label present on the valve with a smartphone gives an instantaneously access to all updated information related to the product, such as:

- valve's and tanks detailed configuration;
- manuals;
- spare parts lists;
- troubleshooting recommendations;
- multi-lingual videos, detailing how to best service a part;
- informations about new products, latest technologies, novelties about the Blue Network program, etc.

1. Download the application **Pentair Scan** from or in a smartphone.

### Mandatory



**The app must be open to scan and identify Pentair products!**

2. Open the **Pentair Scan** application.
3. Either scan the serial number and part number from the product label or enter them manually.
  - ⇒ For serial label location, refer to Serial label location [→Page 12].
4. Navigate to find information.

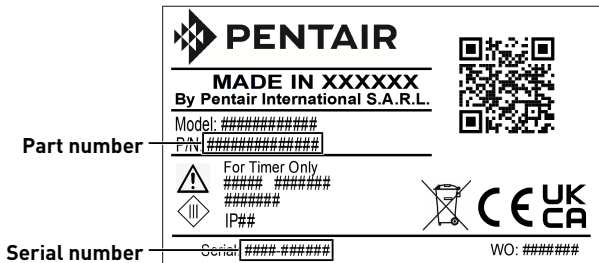

## 2 Safety

### 2.1 Safety pictograms definition

#### DANGER



This combination of symbol and keyword indicates an imminently hazardous situation that will result in serious or fatal injury if not avoided.

#### WARNING



This combination of symbol and keyword indicates a potentially hazardous situation that can result in serious or fatal injury if not avoided.

#### CAUTION



This combination of symbol and keyword indicates a potentially hazardous situation that can result in minimal or minor injury if not avoided.

#### Caution - material



This combination of symbol and keyword indicates a potentially hazardous situation that can result in material damage if not avoided.

#### Prohibition



Mandatory advice to follow.

#### Mandatory



Applicable guideline, measure.

#### Info



Informative comment.

## 2.2 Serial label location

### Europe

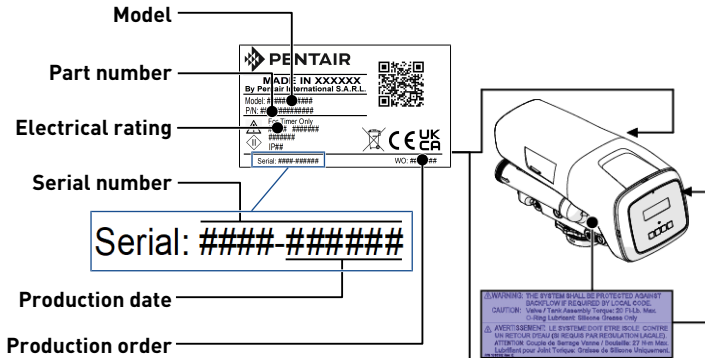

### NAM

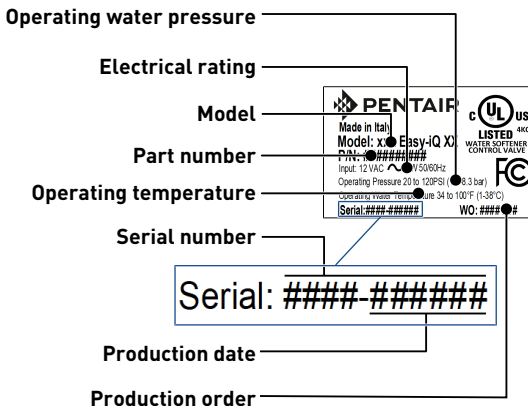

**Mandatory**

**!** Ensure that the serial label and the safety labels on the device are completely legible and clean !

## 2.3 Hazards

All the safety and protection instructions contained in this document must be observed in order to avoid temporary or permanent injury, damage to property or environmental pollution.

At the same time, any other legal regulations, accident prevention and environmental protection measures, as well as any recognized technical regulations relating to appropriate and risk-free methods of working which apply in the country and place of use of the device must be adhered to.

Any non-observation of the safety and protection rules, as well as any existing legal and technical regulations, will result in a risk of temporary or permanent injury, damage to property or environmental pollution.



This product is not intended to be used for treating water that is microbiologically unsafe or of unknown quality without adequate disinfection before or after the product.

### 2.3.1 Personnel

#### CAUTION



#### **Risk of injury due to improper handling!**

Only qualified and professional personnel, based on their training, experience and instruction as well as their knowledge of the regulations, safety rules and operations performed, are authorized to carry out necessary work.

#### WARNING



#### **Appliance**

This appliance can be used by children aged from 8 years and above and persons with reduced physical, sensor or mental capabilities or lack of experience and knowledge if they have been given supervision or instruction concerning use of the appliance in a safe way and understand the hazards involved.

#### WARNING



#### **Children**

Children shall not play with the appliance.

Cleaning and salt refill shall not be made by children without supervision.

#### **Mandatory**



**Any other maintenance operation must be carried out only by qualified and professional personnel!**

### 2.3.2 Material

The following points must be observed to ensure proper operation of the system and the safety of user:

- be careful of high voltages present on the transformer (100 – 240 V);
- do not put your fingers in the system (risk of injuries with moving parts and shock due to electric voltage).

## 2.4 Hygiene and sanitization

### 2.4.1 Sanitary issues

#### **Preliminary checks and storage**

- Check the integrity of the packaging. Check that there is no damage and no signs of contact with liquid to make sure that no external contamination occurred;
- the packaging has a protective function and must be removed just before installation. For transportation and storage, appropriate measures should be adopted to prevent the contamination of materials or the objects themselves.

## Assembly

- Assemble only with components which are in accordance with drinking water standards;
- after installation and before use, perform one or more manual regenerations in order to clean the media bed. During such operations, do not use the water for human consumption. Perform a disinfection of the system in the case of installations for treatment of drinking water for human use.

### Info



**This operation must be repeated in the case of ordinary and extraordinary maintenance.**

It should also be repeated whenever the system remains idle for a significant time.

### Info



**Valid only for Italy**

In case of equipment used in accordance with the DM25, apply all the signs and obligations arising from the DM25.

## 2.4.2 Hygiene measures

### Disinfection

- The materials used for the construction of our products meet the standards for use with potable water; the manufacturing processes are also geared to preserving these criteria. However, the process of production, distribution, assembly and installation, may create conditions of bacterial proliferation, which may lead to odor problems and water contamination;
- it is therefore strongly recommended to sanitize the products. See Sanitization [[→Page 98](#)];
- maximum cleanliness is recommended during the assembly and installation;
- for disinfection, use Sodium or Calcium Hypochlorite and perform a manual regeneration.

## 3 Description

### 3.1 Technical specifications

#### Design specifications/ratings

Valve body	Glass-filled Noryl® - NSF listed material
Rubber components	Compounded for cold water - NSF listed material
Valve material certification	WQA Gold Seal Certified to ORD 0902, NSF/ANSI 44, CE, ACS
Weight (valve with controller)	2.42 kg – 4.41 lbs
Recommended operating pressure	1.4 to 8.3 bar – 20 to 120 psi – 0.14 to 0.83 MPa Canada specific: 1,4 to 6,9 bar – 20 to 100 psi – 0.14 to 0.69 MPa
Hydrostatic test pressure	20.69 bar – 300 psi – 2.07 MPa
Water temperature	1 to 38°C – 35 to 100°F
Ambient temperature	3 to 40°C – 37 to 104°F

#### Flow rates (valve only)

Service at 1.03 bar (15 psi – 0.103 MPa) drop	5.7 m <sup>3</sup> /h – 25 gpm
Backwash at 1.72 bar (25 psi – 0.172 MPa) drop	4.5 m <sup>3</sup> /h – 20 gpm
Service	Kv = 5.6 m <sup>3</sup> /h - Cv = 6.50 gpm
Backwash	Kv = 3.5 m <sup>3</sup> /h - Cv = 4.00 gpm

#### Valve connections

Tank Thread	2½" – 8 NPSM, male
Inlet/Outlet Thread	1-¾" 12 UNC – 2A male
Drain line	¾" NPT, male
Brine line	3/8" NPT, male
Distributor tube [Ø]	27 mm (1.05")
Distributor tube length	13 mm ± 3 mm (½ ± 1/8") above top of tank
Inlet/Outlet Manifold	Connection kit ¾" and 1"

#### Electrical

Controller Operating Voltage*	12 VAC (requires use of Pentair Water supplied transformer)
Input Supply Frequency	50 or 60 Hz
Motor Input Voltage*	12 VAC
Controller Power Consumption	6 W
Protection rating	IP23

\*Temporary overvoltage must be limited both in duration and frequency.

**Environmental conditions**

- Use only indoors. Some exceptions are reported in Outdoor Locations [->Page 35];
- Temperature from 3°C – 37F to 40°C – 104°F;
- Maximum relative humidity 80% for temperatures up to 31°C – 88°F decreasing linearly to 50% relative humidity at 40°C – 104°F;
- Supply voltage fluctuations up to ±10% of the nominal voltage;
- Caution: install in a dry place only.

**3.2 Performance flow rate characteristics**

The graph shows the pressure drop created by the valve itself at different flow rates. It allows predetermining the maximum flow rate going through the valve depending on the system settings (inlet pressure etc). It also allows to determine the valve pressure drop at a given flow rate, and therefore to evaluate the system pressure drop vs flow rate.

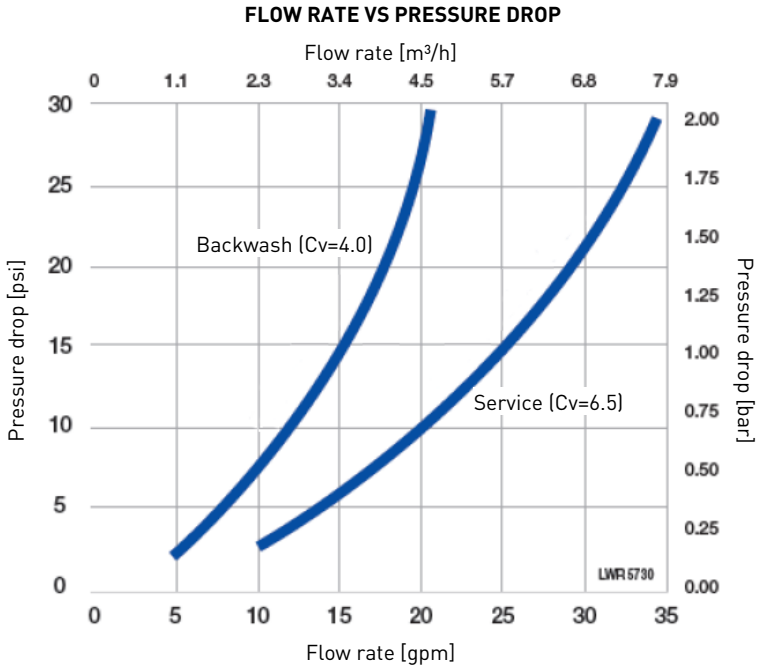

### 3.3 Outline drawing

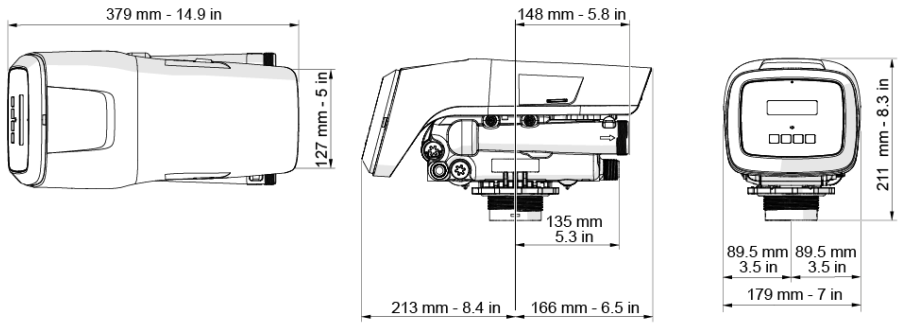

### 3.4 Components description and location

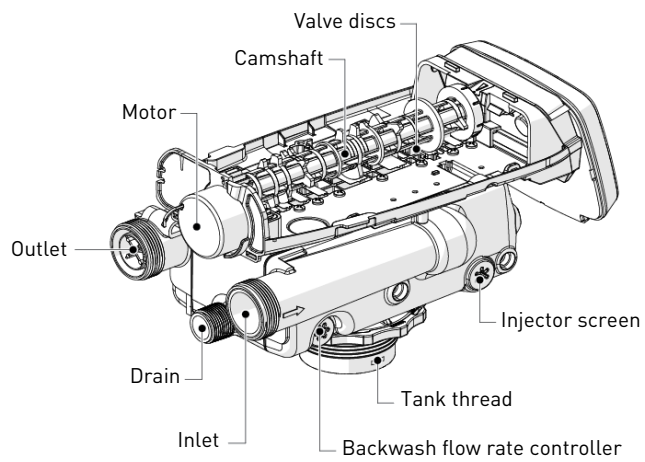
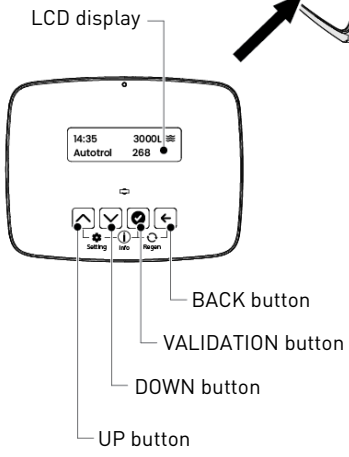
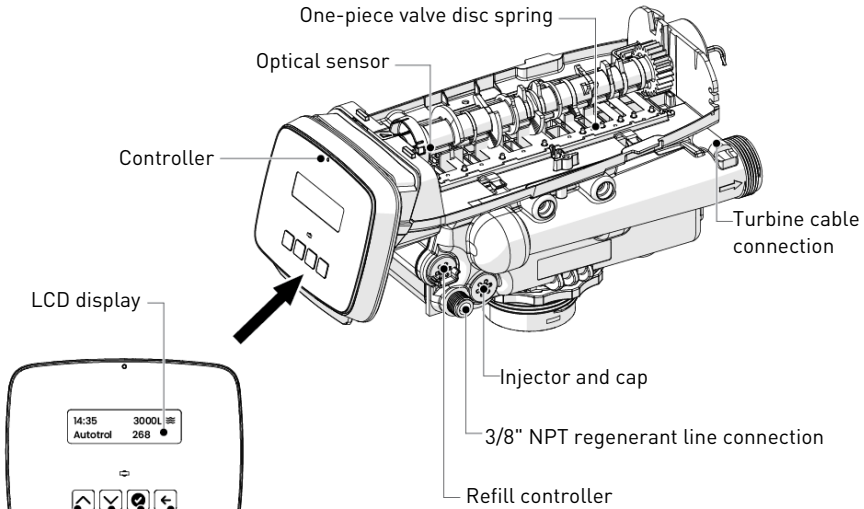

### 3.5 Options available on the valve

#### 3.5.1 Valve Camshaft (Black)

The front end of the camshaft has an indicator cup. The cup has slots in the outer periphery and numbers on the inside face.

The numbers can be seen with the cover off, from the front over the top of the controller. The number at the top indicates which position is currently in progress.

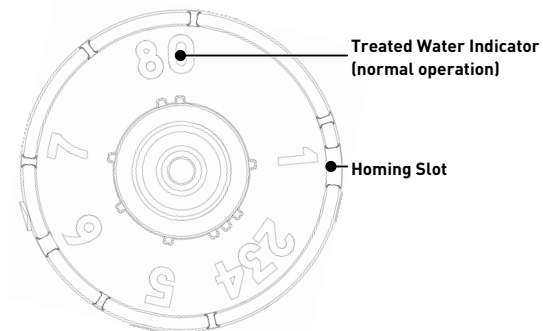

The corresponding slot for the number is positioned at the optical sensor which is approximately 90 degrees out of phase.

#### Regeneration Cycle Indicators

- 0 Treated Water - normal operation mode
- 1 Backwash
- 2 Draw
- 3 Slow Rinse
- 4 Repressurization
- 5 Fast Rinse 1
- 6 Second Backwash
- 7 Fast Rinse 2
- 8 Refill

## Valve Disc Operation

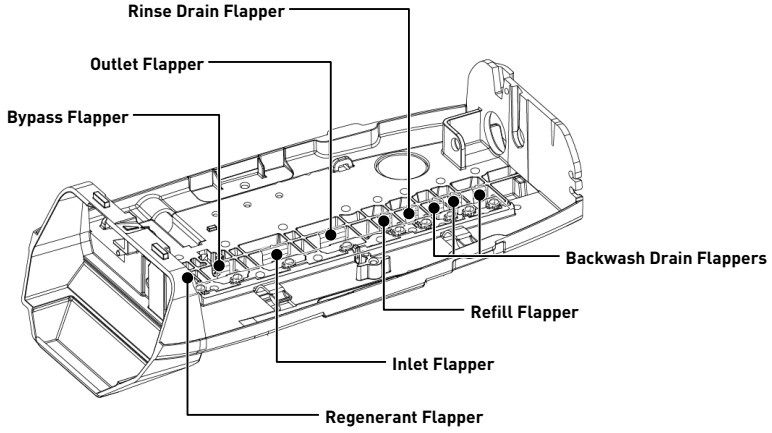



### 3.5.2 Blending valve kit

Tightening the adjusting screw provided by the kit will force the bypass flapper open. The open flapper will allow untreated (hard) water to blend with the treated water supply. As the adjusting screw is turned in, the residual hardness of the outlet water increases.

Loosening the adjusting screw will allow the bypass flapper to close. The closing action will blend less untreated water into the outlet flow.

To blend a specific amount of hardness into outflow, adjust the screw and test the water. Repeat the following procedure as needed until the desired hardness level is reached.

1. Insert the nut (3) into the blending valve orifice (2).
2. Insert the adjusting screw (4) through the top plate and then through the nut.
3. Tighten the adjusting screw (4) until it touches the bypass flapper (1).
4. Adjust the position of the screw (4) until the desired hardness level of water is reached.

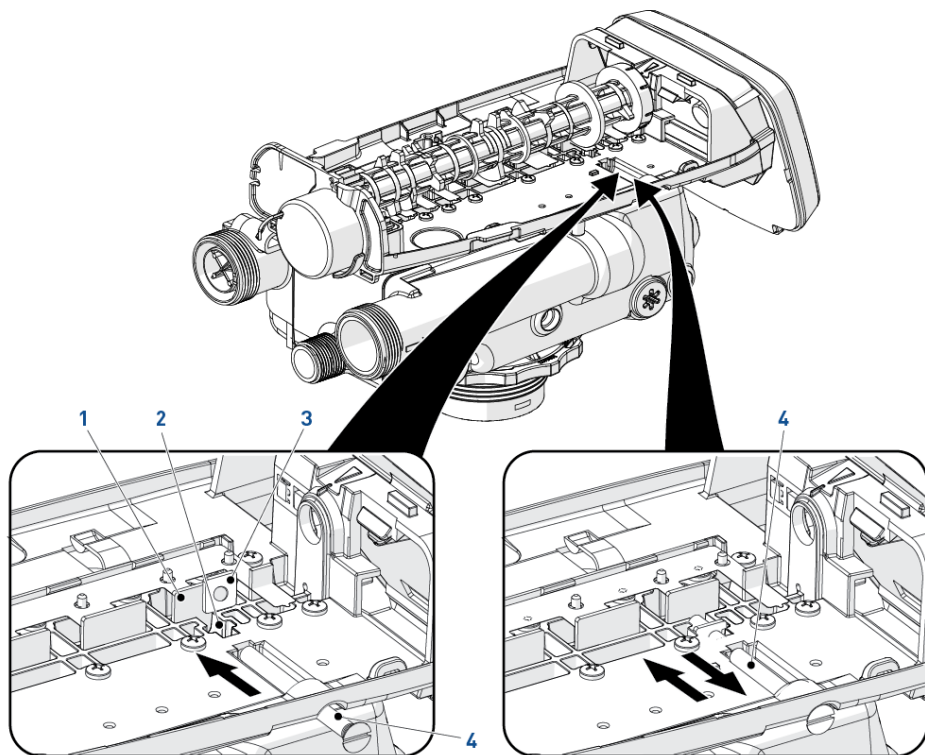

## 3.6 Softener operating mode (8-cycles operation)

### Service (downflow) — cycle C0

Untreated water is directed down through the resin bed and up through the riser tube. The hardness ions attach themselves to the resin and are removed from the raw water being exchanged on the resin beads against sodium ions. The water is conditioned as it passes through the resin bed.

### Backwash (upflow) — cycle C1

The flow of water is reversed by the valve and directed down the riser tube and up through the resin bed. During the backwash cycle, the bed is expanded and debris are flushed to the drain, while the media bed is remixed.

### Brine draw & slow rinse (downflow) — cycle C2-C3

The controller directs water through the brine injector and brine is drawn from the brine tank. The brine is then directed down through the resin bed and up through the riser tube to the drain. The hardness ions are displaced by sodium ions and are sent to the drain. When the air check valve closes brine drawing finishes, and then the slow rinse phase starts. The resin is regenerated during the brine draw and slow rinse cycles.

### Repressurize cycle (hard water bypass flapper open) — cycle C4

This cycle allows the air and water to hydraulically balance in the valve before continuing the regeneration.

### Fast rinse (downflow) — cycle C5

The controller valve directs water down through the resin bed and up through the riser tube to the drain. Any residual brine is rinsed from the resin bed, while the media bed is re-compacted.

### 2nd Backwash (upflow) — cycle C6

2nd backwash allows to reclassify regenerated resins, break channelling from 1st fast rinse and homogenize the resin bed for optimal capacity.

Only if high efficiency mode is programmed.

### 2nd Fast rinse (downflow) — cycle C7

Rinse to quality and re-compacting the resin bed shortly.

Only if high efficiency mode is programmed.

### Brine refill — cycle C8

Water is directed to the brine tank at a rate controlled by the refill controller, to create brine for the next regeneration. During brine refill, treated water is already available at the valve outlet.

#### Info



**For illustration purpose only. Always verify inlet and outlet marking on the valve.**

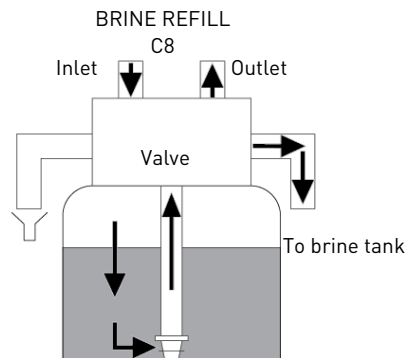
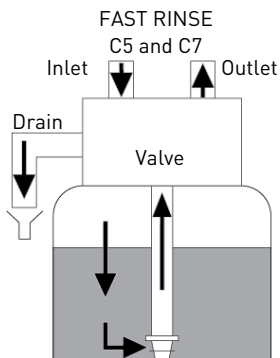
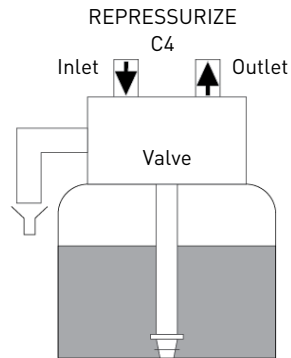
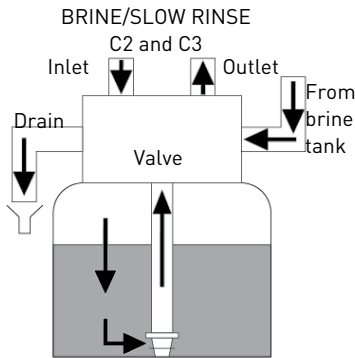
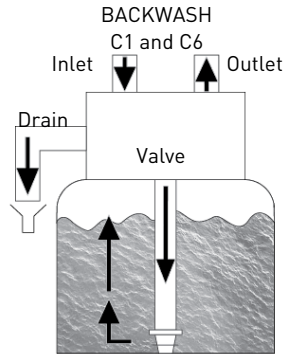
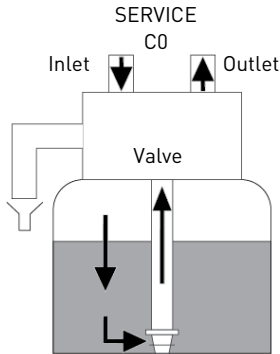

### 3.7 Filter operating mode (3-cycles operation)

#### Service — cycle C0

Unfiltered water is directed down through the media and up through the riser tube. The water is filtered as it passes through the media.

#### Backwash — cycle C1

The flow of water is reversed by the valve and directed down through the riser tube and up through the media. During the backwash cycle, the media is expanded and debris is flushed to the drain.

#### Repressurize cycle (hard water bypass flapper open) — cycle C4

This cycle allows the air and water to hydraulically balance in the valve before continuing the regeneration.

#### Fast rinse — cycle C5

The valve directs water down through the media and up through the riser tube to the drain while the media is re-compacted.

#### Info



#### Note

For illustration purpose only. Always verify inlet and outlet marking on the valve.

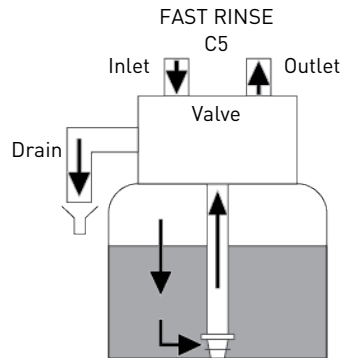
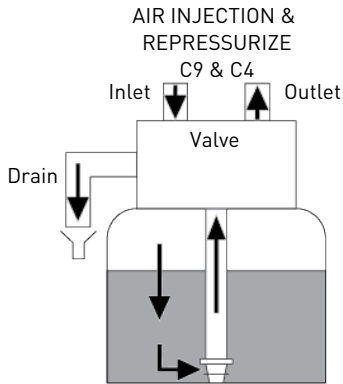
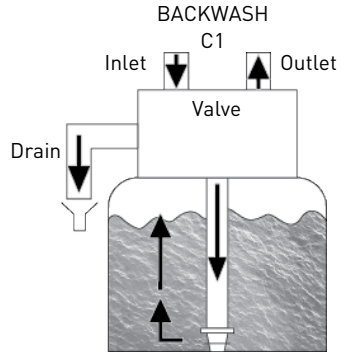
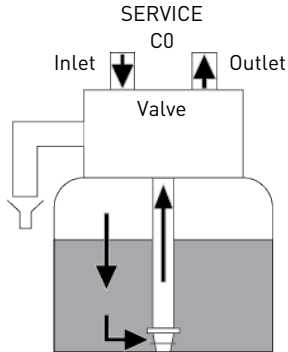

## 4 System sizing

### 4.1 Softener configuration (Performa 268)

#### 4.1.1 Default Injector/DLFC/Refill flow controller - Valve configuration

Vessel diameter [In]	Media volume	Injector Flow control	Refill flow control	Backwash flow control
6	4 to 8 l - 0,18/0,35 cu.ft	E [yellow]	1.5 L/min - 0.33 gpm	4.1 L/min - 0.9 gpm
7	15 l - 0.53 cu.ft	F [peach]		5.5 L/min - 1.2 gpm
8	20 l - 0.71 cu.ft	G [tan]		7.3 L/min - 1.6 gpm
9	30 l - 1.06 cu.ft	H [lt purple]		9.1 L/min - 2.0 gpm
10	35 l - 1.24 cu.ft	J [lt blue]		11.4 L/min - 2.5 gpm
12	40 l - 1.41 cu.ft	K [pink]		15.9 L/min - 3.5 gpm
13	50 l - 1.76 cu.ft	L [orange]		18.6 L/min - 4.1 gpm
14	80 l - 2.86 cu.ft	L [orange]		21.8 L/min - 4.8 gpm

### 4.2 Filter configuration (Performa 263)

In filter configuration, the valve body, the camshaft and the controller are identical to the one used for softening. The only difference is related to the valve configuration.

In filter mode, the injector size installed in the valve does not matter, it is only required to allow intern pressure balancing during cleaning cycles. Refill flow controller is plugged.

The backwash flow rate controller used is now related to the tank size and media type.

### 4.3 Cycle time calculation

The Easy-iQ controller automatically calculates the unit capacity as well as the cycle time. No calculations are therefore required.

Cycle time can however be overridden and modified by the installer if required.

## 4.4 Salt dosage definition

The salt amount is set in kilograms of salt used for each regeneration. This setting will greatly influence the system performances. Make sure this setting is aligned with your actual system size and system # programmed.

Salt dosage and corresponding exchange capacity for standard regeneration efficiency:

Salt amount	Corresponding Resin Exchange Capacity [g/Lresin as CaCO <sub>3</sub> ]	°f/m <sup>3</sup>	°d/m <sup>3</sup>
50 [g/Lresin] 3.12 [lb/cu.ft]	29.9	2.99	1.67
60 [g/Lresin] 3.74 [lb/cu.ft]	34.0	3.40	1.90
70 [g/Lresin] 4.37 [lb/cu.ft]	37.5	3.75	2.09
80 [g/Lresin] 4.99 [lb/cu.ft]	40.6	4.06	2.27
90 [g/Lresin] 5.62 [lb/cu.ft]	43.4	4.34	2.42
100 [g/Lresin] 6.24 [lb/cu.ft]	45.9	4.59	2.56
110 [g/Lresin] 6.87 [lb/cu.ft]	48.2	4.82	2.69
120 [g/Lresin] 7.49 [lb/cu.ft]	50.2	5.02	2.80
130 [g/Lresin] 8.11 [lb/cu.ft]	52.1	5.21	2.91
140 [g/Lresin] 8.74 [lb/cu.ft]	53.8	5.38	3.01
150 [g/Lresin] 9.36 [lb/cu.ft]	55.5	5.55	3.10
170 [g/Lresin] 10.61 [lb/cu.ft]	58.5	5.85	3.27
200 [g/Lresin] 12.48 [lb/cu.ft]	62.7	6.27	3.50
230 [g/Lresin] 14.36 [lb/cu.ft]	66.9	6.69	3.74

Salt amount	Corresponding Resin Exchange Capacity [g/Lresin as CaCO3]	°f/m <sup>3</sup>	°d/m <sup>3</sup>
260 [g/Lresin] 16.23 [lb/cu.ft]	71.0	7.10	3.97
290 [g/Lresin] 18.10 [lb/cu.ft]	75.3	7.53	4.21

Salt dosage and corresponding exchange capacity for high regeneration efficiency:

Salt amount	Corresponding Resin Exchange Capacity [g/Lresin as CaCO3]	°f/m <sup>3</sup>	°d/m <sup>3</sup>
50 [g/Lresin] 3.12 [lb/cu.ft]	33.6	3.36	1.88
60 [g/Lresin] 3.74 [lb/cu.ft]	40.0	4.00	2.23
70 [g/Lresin] 4.37 [lb/cu.ft]	44.5	1.45	2.49
80 [g/Lresin] 4.99 [lb/cu.ft]	48.4	4.84	2.70
90 [g/Lresin] 5.62 [lb/cu.ft]	51.8	5.18	2.89
100 [g/Lresin] 6.24 [lb/cu.ft]	54.9	5.49	3.07
110 [g/Lresin] 6.87 [lb/cu.ft]	57.7	5.77	3.22
120 [g/Lresin] 7.49 [lb/cu.ft]	60.2	6.02	3.36
130 [g/Lresin] 8.11 [lb/cu.ft]	62.6	6.26	3.50
140 [g/Lresin] 8.74 [lb/cu.ft]	64.8	6.48	3.62
150 [g/Lresin] 9.36 [lb/cu.ft]	66.8	6.68	3.73
170 [g/Lresin] 10.61 [lb/cu.ft]	70.4	7.04	3.93
200 [g/Lresin] 12.48 [lb/cu.ft]	75.2	7.52	4.20



Salt amount	Corresponding Resin Exchange Capacity [g/Lresin as CaCO <sub>3</sub> ]	°f/m <sup>3</sup>	°d/m <sup>3</sup>
230 [g/Lresin] 14.36 [lb/cu.ft]	79.3	7.93	4.43
260 [g/Lresin] 16.23 [lb/cu.ft]	82.9	8.29	4.63
290 [g/Lresin] 18.10 [lb/cu.ft]	86.1	8.61	4.81

## 4.5 Injector flow rates

The following graphs represent the injectors flow rate as a function of the inlet pressure for the different injector sizes.

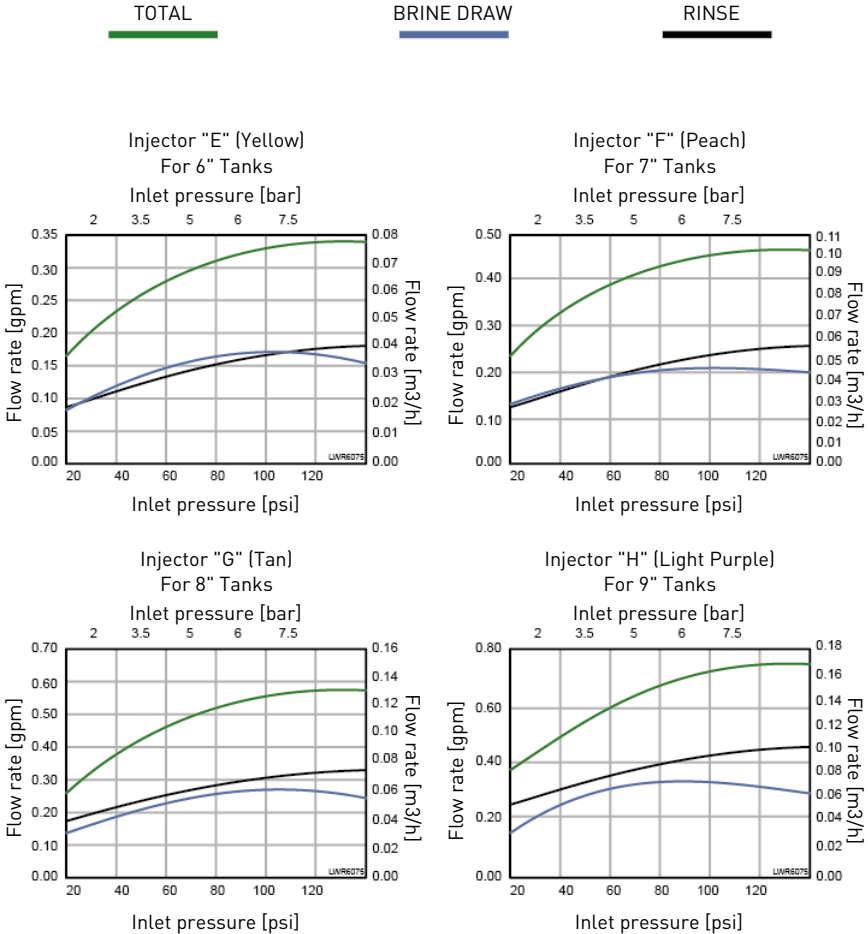

**TOTAL**

**BRINE DRAW**

**RINSE**

Injector "J" (Light Blue)  
For 10" Tanks

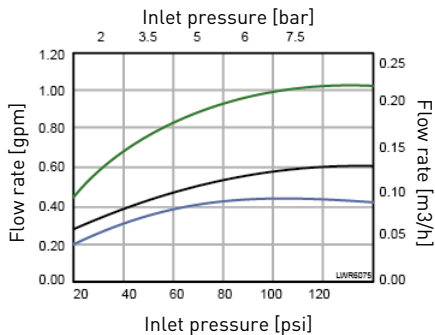

Injector "K" (Pink)  
For 12" Tanks

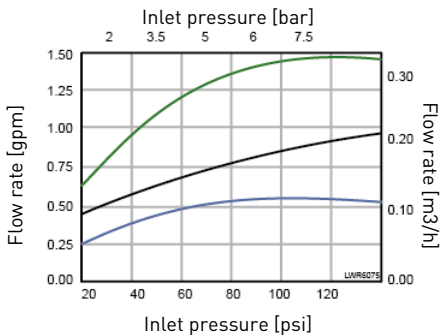

Injector "L" (Orange)  
For 13" and 14" Tanks

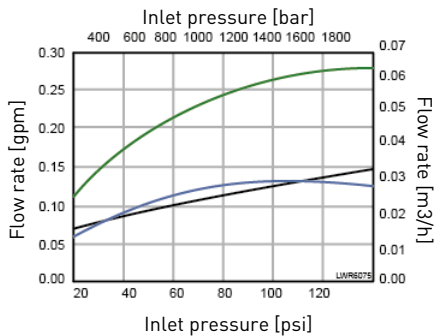

## 5 Installation

### CAUTION



#### **Risk of injury due to electrical shock or pressurized elements !**

It is strictly forbidden for not qualified personal, to accede to system's internal parts to perform any kind of technical action.

Be sure to disconnect the electrical power, close the water inlet and depressurize the system before opening the front cover to access internal parts !

### 5.1 Product identification

#### Info



**The Performa 263-268 Easy-iQ product is sold in several configurations; It is important to identify your configuration before proceeding with installing the product.**

First check whether the product is already equipped with a power supply or not; if it is not present, the product must be powered with the following characteristics:

Output current frequency	50/60 Hz	Minimum power absorption	6 W
Output current voltage	12 VAC	Insulation Class	II
Connector Type	O.D. 5.5 mm x I.D. 2.1 mm		

The input characteristics of the power supply depend on the electrical network available on site.

### DANGER



**The choice of a correct power supply is mandatory to guarantee the safety of users, if you do not feel expert, consult a professional.**

The power supplies that Pentair supplies with the product are different and can be recognized by the part number on the power supply data plate; and these are:

Part number	Type	Plug type	Input electrical rating
1000814	European Transformer	Type C	230 VAC; 50/60 Hz
1000813	UK Transformer	Type G	230-240 VAC; 50/60 Hz
1000810	Japanese Transformer	Type A	100 VAC; 50/60 Hz
1000812	Australian Transformer	Type I	240 VAC; 50/60 Hz
44149	North American Transformer	Type A	120 VAC; 50/60 Hz
44156	Outdoor North American Transformer	Type B	120 VAC; 50/60 Hz

#### Mandatory



**Always check first if the supplied transformer is compatible with the local electrical network!**

### 5.2 Safety notices for installation

- Observe all warnings that appear in this manual;

- only qualified and professional personnel are authorized to carry out installation work.

## 5.3 Installation environment

### 5.3.1 General

- Use only regenerant salts designed for water softening. Do not use ice melt, block, or rock salts;
- keep the media tank in an upright position. Do not turn on its side, upside down, or drop it. Turning the tank upside down may cause media to enter the valve or might clog the upper screen;
- follow State and local codes for water testing. Do not use water that is micro-biologically unsafe or of unknown quality;
- when filling the media tank with water, first place the valve in the backwash position, then partly open the manual valve. Fill the tank slowly to prevent media from exiting the tank;
- when installing the water connection (bypass or manifold), first connect to the plumbing system. Allow heated parts to cool and cemented parts to set before installing any plastic parts. Do not get primer or solvent on O-rings, nuts, or the valve.

### 5.3.2 Water

#### CAUTION



**Do not treat water under 1°C – 35°F or over 38°C – 100°F, hot water would damage the softener and void warranty.**

- If you are on a private well system, check minimum water pressure with an accurate gauge (gauges on older water systems are often inaccurate). Static pressure that is less than 2 bar – 29 psi – 0.2 MPa may cause low flow rate and inadequate regeneration, depending by the pressure drop of the system as a minimum of 1.38 bar – 14.5 psi – 0.138 MPa dynamic pressure (on injector at 20 l/min – 5.28 gpm) of water is required for the valve's injector to operate effectively;

#### Mandatory



**Do not exceed a maximum of 8.6 bar – 120 psi – 0.86 MPa inlet pressure. Should this happen or be subject to happen, it is necessary to install a pressure regulator upstream the system.**

### 5.3.3 Electrical

#### **DANGER**



#### **Improper connection of the appliance-grounding conductor**

Risk of electric shock

If outdoor North American transformer is used, check with a qualified electrician or service representative if you are in doubt whether the appliance is properly grounded.

Do not modify the plug provided with the appliance; if it will not fit the outlet, have a proper outlet installed by a qualified technician.

Wire all Class 2 circuits using Types CL3, CL3R, CL3P, or equivalent conductors.

Wire all circuits as Class 1, Electric Light, or Power circuits.

Wire all circuits with insulation rated 120 VAC min.

There are no user-serviceable parts in the AC/AC transformer, motor, or controller. In the event of a failure, these should be replaced.

- All electrical connections must be completed according to local codes;
- use only the power AC/AC transformer that is supplied;

#### Mandatory



#### **The use of any power transformer other than the one supplied void the warranty of all electronic parts of the valve!**

- If outdoor North American transformer is used, this appliance must be grounded. In the event of a malfunction or breakdown, grounding will reduce the risk of electric shock by providing a path of least resistance for electric current. This appliance is equipped with a cord having an appliance-grounding conductor and a grounding plug. The plug must be plugged into an appropriate outlet that is installed and grounded in accordance with all local codes and ordinances;
- the power outlet must be grounded;
- to disconnect power, unplug the AC/AC transformer from its power source;
- an uninterrupted current supply is required. Please make sure that the voltage supply is compatible with the unit before installation;
- make sure the controller power source is plugged in;
- if the electrical cable is damaged, it is imperative that it is replaced by qualified personnel.

### 5.3.4 Mechanical

#### Caution - material



#### **Risk of damage due to wrong lubricant use !**

Do not use petroleum-based lubricants such as vaseline, oils, or hydrocarbon-based lubricants.

Use only approved silicone grease or soapy water !

- All plastic connections should be hand-tightened. PTFE (plumber's tape) may be used on connections that do not use an O-ring seal. Do not use pliers or pipe wrenches;
- existing plumbing should be in a good shape and free from limescale. In case of doubt, it is preferable to replace it;
- all plumbing must be completed according to local codes and installed without tension or bending stresses;
- soldering near the drain line should be done before connecting the drain line to the valve. Excessive heat will cause interior damage to the valve;
- do not use lead-based solder for sweat solder connections;
- the drain line may be elevated up to 1.8 m – 39.4" providing the run does not exceed 4.6 m – 181" and water pressure at the softener is not less than 2.76 bar – 40 psi – 0.276 MPa. Elevation can increase by 61 cm – 24" for each additional 0.69 bar – 10 psi – 0.069 MPa of water pressure at the drain connector;
- the drain line must be a minimum of 12.7 mm - ½" in diameter. Use 19 mm - ¾" pipe if the backwash flow rate is greater than 26.5 l/min – 5 gpm or the pipe length is greater than 6 m – 20 ft;
- do not support the weight of the system on the valve fittings, plumbing, or the bypass;
- it is not recommended to use sealants on the threads. Use PTFE (plumber's tape) on the threads of the drain elbow, and other NPT/BSP threads;
- the installation of a pre-filter is always recommended (100µ nominal);
- valve inlet/outlet must be connected to main piping via flexible.

### 5.3.5 Outdoor Locations

When the water softening system is installed outdoors, several points must be considered:

- power supply - only products with an outdoor power supply, with P/N 44156, can be installed outdoors;
- moisture — The valve and Easy-iQ controller are rated for IP23 locations. Falling water should not affect performance. The system is not designed to withstand extreme humidity or water spray from below. Examples are: constant heavy mist, near corrosive environment, upwards spray from sprinkler;
- direct sunlight — The materials used will fade or discolour over time in direct sunlight. The integrity of the materials will not degrade to cause system failures. Avoid to install the softener in direct sunlight;
- temperature — Extreme hot or cold temperatures may cause damage to the valve or controller. Freezing temperatures will freeze the water in the valve. This will cause physical damage to the internal parts as well as the plumbing. High temperatures will affect the controller. The display may become unreadable but the controller should continue to function. When the temperature drops back into normal operating limits the display will return to normal;
- insects — The controller and valve have been designed to prevent all but the smallest insects from entering critical areas. All holes in the top plate can be covered with a sheet of duct tape. The top cover must be installed securely in place.;

- wind — The Easy-iQ cover is designed to withstand a 48 km/h – 29.8 mph wind when properly installed on the valve.

## 5.4 Integration constraints

Location of a water treatment system is important. The following conditions are required:

### CAUTION



**The surface for installation (platform or floor) must be solid, flat and level.**

### Mandatory



**Drain must be capable of handling a backwash flow rate of 19 /min – 5 gpm.**

- locate the softener as close as possible from drain discharge point and within 12.2 m – 40 ft maximum of drain discharge point, respecting minimum drain line diameter advises given at chapter Drain line connection [→Page 43];
- room to access equipment for maintenance and adding brine (salt) to tank;
- constant electrical supply to operate the controller;
- total minimum pipe run to water heater of 3 m – 9.8 ft to prevent backup of HW into system;
- always install check valve before water heater to protect the softener from HW return;
- local drain for discharge as close as possible;
- water line connections with shut off or bypass valves;
- must meet any local and state codes for site of installation;
- valve is designed for minor plumbing misalignments. Do not support weight of system on the plumbing;
- use flexible piping to connect main piping to softener;
- be sure all soldered pipes are fully cooled before attaching plastic valve to the plumbing.



## 5.5 Block diagram and configuration example

### Block diagram

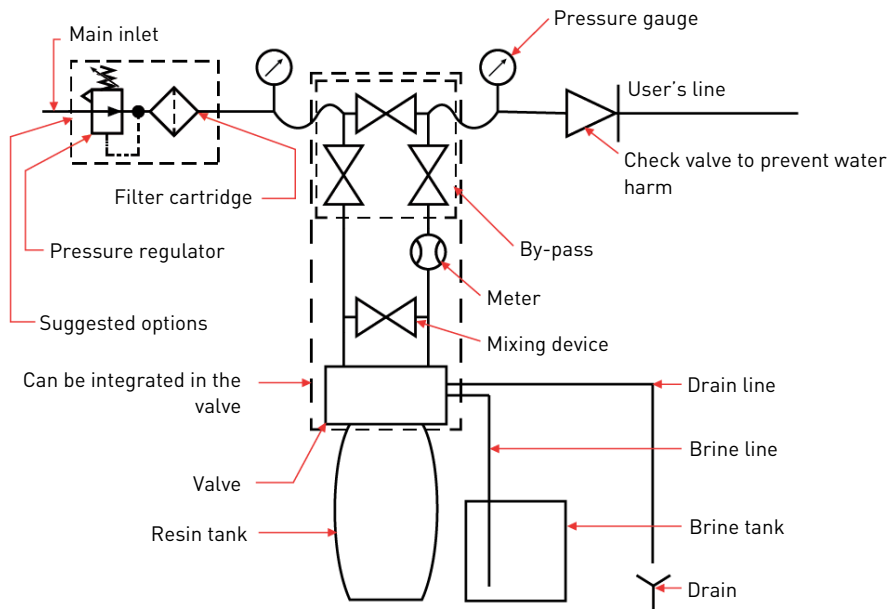

**Configuration example:  
Performa 263**

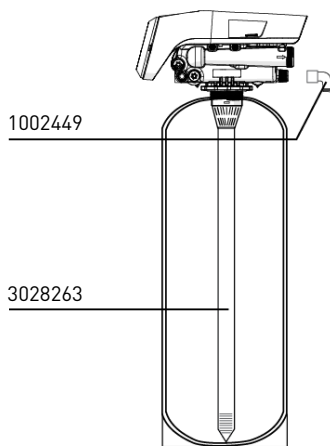

**Configuration example:  
Performa 268 HiEF, STD**

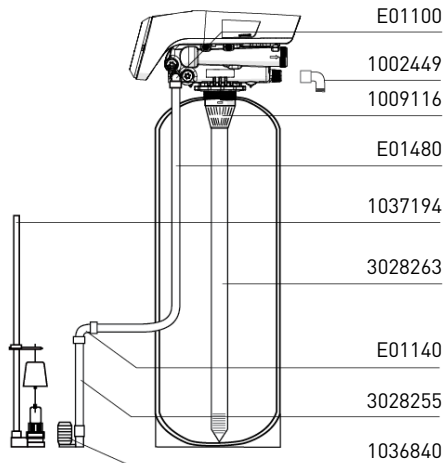

Correct drain line flow control must be fitted depending on media type and vessel size.

## 5.6 Valve on tank assembly

1. Lubricate the seals with approved silicone grease.
2. Spin the valve (1) onto the tank (2), ensuring the threads are not cross-threaded.
3. Rotate the valve (1) clockwise and freely, without using force until it comes to a stop.

### Info



**This stop position is considered point zero.**

4. Rotate the valve (1) clockwise from point zero to between  $\frac{1}{4}$  turn and  $\frac{1}{2}$  turn.

### Caution - material



**Risk of damage due to excessive force!**

Do NOT exceed 27 Nm - 19.9 ft-lb of torque when installing the valve. Exceeding this limit may damage the threads and cause failure.

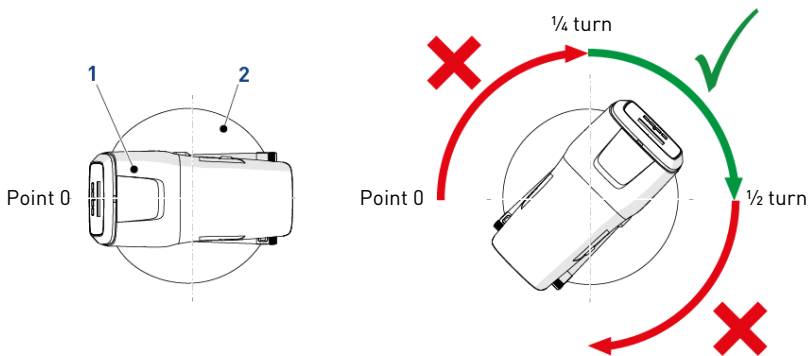

## 5.7 Valve connection to piping

The connections should be hand tightened using PTFE (plumber's tape) on the threads if using the threaded connection type.

In case of heat welding (metal type connection), the connections should not be made to the valve when soldering.

### Tip



**See chapter Components description and location [→Page 18] to identify the connections.**

When pressurized, any composite tank will expand both vertically and circumferential. In order to compensate the vertical expansion, the piping connections to the valve must be flexible enough to avoid overstress on the valve and tank.

### 5.7.1 Top-mounted valve installation

The valve and tank should not be supporting any part of the piping weight. This is hence compulsory to have the piping fixed to a rigid structure (e.g. frame, skid, wall...) so that the weight of it is not applying any stress on the valve and tank.

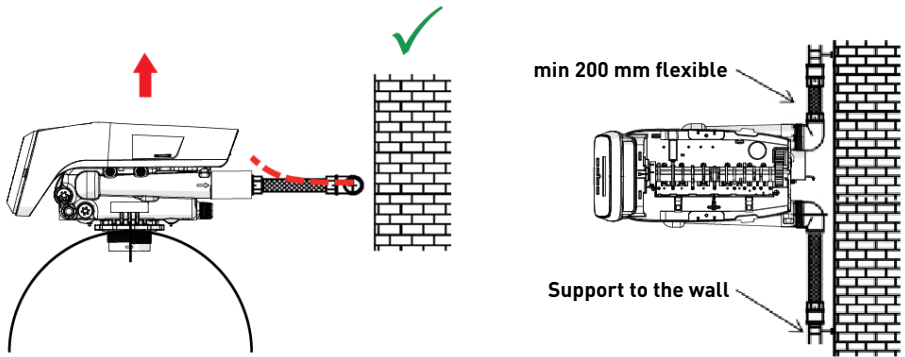

- The diagrams above illustrate how the flexible piping connection should be mounted;
- in order to adequately compensate the tank elongation the flexible tubes must be installed **horizontally**;
- should the flexible piping connection be installed in vertical position, instead of compensating the elongation, it will create additional stresses on the valve & tank assembly. Therefore this is to be avoided;
- the flexible piping connection must also be installed stretched, avoiding excessive length. For instance 20 to 40 cm - 7,9 to 15,8 in is enough;
- excessively long and non-stretched flexible piping connection will create stresses on the valve and tank assembly when the system is pressurised, as illustrated in the below picture: on the left the assembly when the system is unpressurised, on the right the flexible piping connection when put under pressure tends to lift up the valve when stretching up. This configuration is even more dramatic when using semi-flexible piping;
- failure to provide enough vertical compensation may lead to different kinds of damage, either on the valve thread which is connected to the tank, or on the female thread connection of the tank. In some cases, damage may also be seen on the valve inlet and outlet connections;

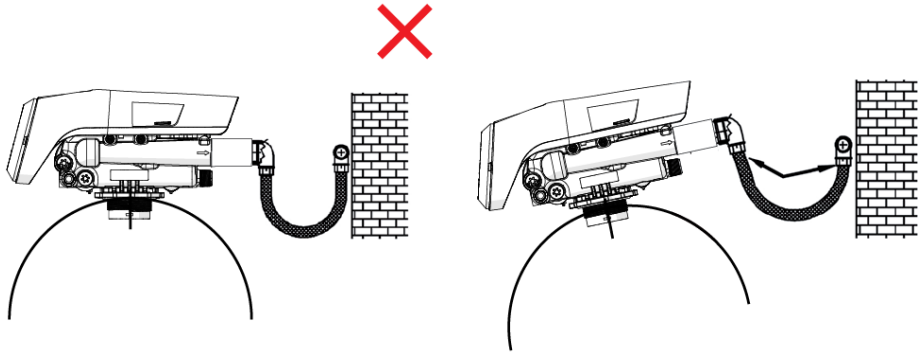

- in any case, any failure caused by improper installations and/or piping connections may void the warranty of Pentair products;
- in the same way, using lubricant\* [→Page 40] on the valve thread is not allowed and will void the warranty for the valve and tank. Indeed using lubricant there will cause the valve to be over-torqued, which may lead to valve thread or tank thread damage even if the connection to piping has been done following the above procedure.

\*Note: Do not use petroleum or hydrocarbon-based lubricants. Using these types of lubricants will structurally damage valve and cause failures. Use only 100% silicone lubricants.

## 5.8 Regeneration mode

### Time clock

A Time Clock mode system initiates regeneration upon a determined interval of days between two regenerations. The controller will initiate a regeneration at the programmed regeneration time when the number of days since the last regeneration equals the number of days between two regenerations programmed. When this regeneration mode is programmed, the number of days between two regenerations shall be programmed in the Settings menu.

### Time clock Day of the week

A time clock day of the week mode system initiates regeneration upon the day of the week. When this regeneration mode is programmed, each day of the week can be activated/deactivated for regeneration in the Settings menu by programming **ON/OFF** for each day. The controller will initiate a regeneration on days that have been set to **ON** at the specified regeneration time.

### Meter Immediate

Measures water usage and regenerates the system as soon as the capacity is depleted. The controller calculates the system capacity by dividing the unit capacity by the programmed water hardness. Softener Immediate systems do not use a reserve volume. In meter immediate mode, the controller will also initiate regeneration upon the calendar override value if applicable.

### Meter delayed

Measures water usage and books a regeneration at the programmed regeneration time after the programmed system remaining capacity has reached the reserve amount. The controller calculates the system capacity by dividing the unit capacity by the programmed water hardness.

Reserves can be set at a fixed volume, fixed percentage of capacity, a variable reserve based on the previous calendar day's water usage, or a weekly reserve based on the average water usage for the current day of the week. If the reserve is set manually, in order to avoid hardness breakthrough at service cycle end, an average of 1 day of production should be considered for reserve volume. The default reserve type is weekly reserve.

In meter delayed mode, the controller will also initiate regeneration upon the calendar override value if applicable.

## 5.9 Electrical connection

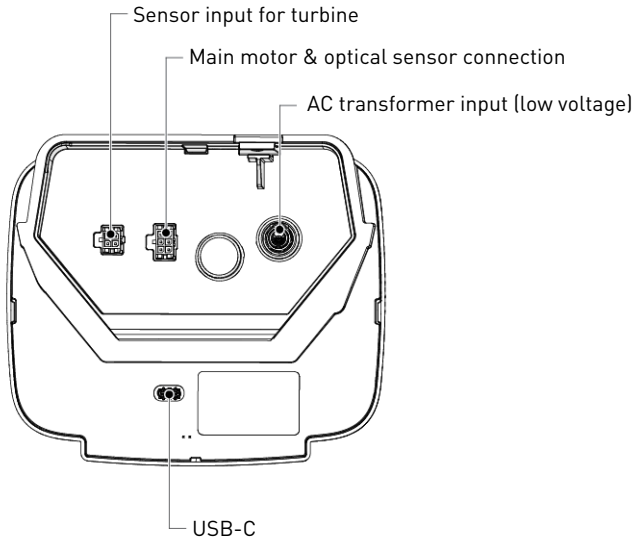

## 5.10 Bypassing

A bypass valve system should be installed on all water conditioning systems. Bypass valves isolate the softener from the water system and allow unconditioned water to be used and also maintains the continuity of the water supply when the product is disconnected. Service or routine maintenance procedures may also require that the system is bypassed.

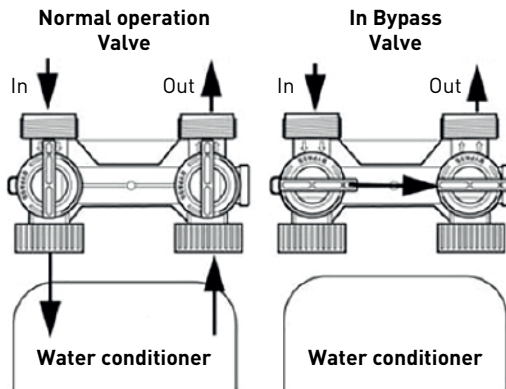

**Caution - material**

**Risk of damage due to bad mounting!**

Do not solder pipes with lead-based solder.

Do not use tools to tighten plastic fittings. Over time, stress may break the connections. When the bypass valve is used, only hand tighten the plastic nuts.

Do not use petroleum grease on gaskets when connecting bypass plumbing. Use only 100% silicone grease products when installing any plastic valve. Non-silicone grease may cause plastic components to fail over time.

## 5.11 Drain line connection

**Info**

**Standard commercial practices are expressed here.**

Local codes may require changes to the following suggestions.

Check with local authorities before installing a system.

**Mandatory**

**The drain line must be build with 3/4" semi rigid or rigid piping ! An air gap must be present at the drain!**

**Caution - material**

**Risk of damage due to over-force !**

The drain line plastic elbow must always be hand-tighten without using the elbow as a lever.

The drain plastic elbow is not designed to support the weight of the tube. The tube has to have its own support.

Do not over tighten the hose tightening ring on its plastic support.

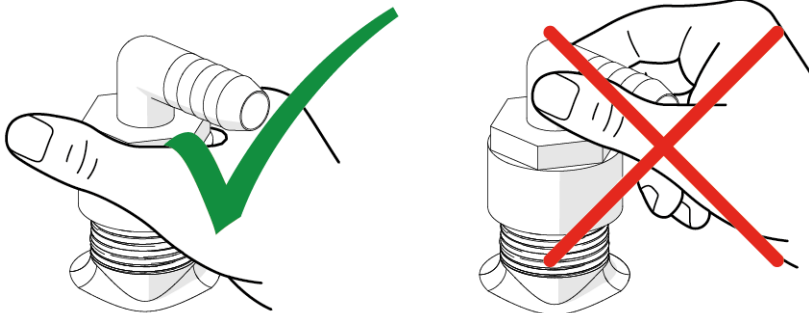

Apply sealing tape on the male thread of the valve.

The unit should not be more than 6.1 m – 20 ft from the drain. Use an appropriate adapter fitting to connect 12.7 mm – 1/2" plastic tubing to the drain line connection of the control valve.

If the backwash flow rate exceeds 22.7 l/min – 6.0 gpm or if the unit is located 6.1 m – 236” to 12.2 m – 472” from the drain, use 19 mm (3/4”) tubing. Use appropriate fittings to connect the 19 mm (3/4”) tubing to the 19 mm (3/4”) NPT drain connection on the valve.

The drain line may be elevated up to 1.8 m – 40” providing the run does not exceed 4.6 m – 157.5” and water pressure at the softener is not less than 2.76 bar – 29 psi – 0.276 MPa. Elevation can increase by 61 cm – 23.6” for each additional 0.69 bar – 8.7 psi – 0.069 MPa of water pressure at the drain connector.

Where the drain line is elevated but empties into a drain below the level of the valve, form a 18 cm – 3.9” loop at the far end of the line so that the bottom of the loop is level with the drain line connection. This will provide an adequate siphon trap.

Where the drain empties into an overhead sewer line, a sink-type trap must be used.

Secure the end of the drain line to prevent it from moving.

#### Mandatory



**Waste connections or the drain outlet shall be designed and constructed to provide connection to the sanitary waste system through an air-gap of 2 pipe diameters or 25.4 mm (1”), whichever is larger.**

#### Caution - material



#### Risk of damage due to lack of gap !

Never insert the drain line directly into a drain, sewer line or trap. Always allow an air gap between the drain line and the waste water to prevent the possibility of sewage being back-siphoned into the softener.

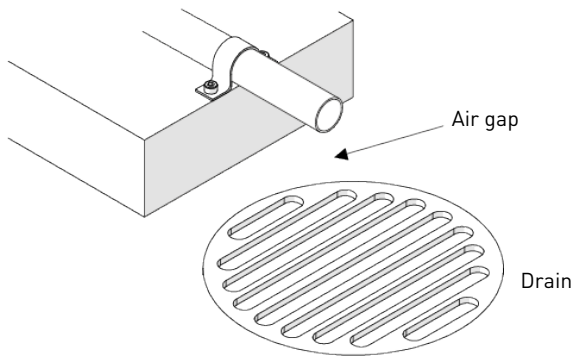

## 5.12 Overflow line connection

In the event of a malfunction, the brine tank overflow fitting will direct “overflow” to the drain instead of spilling on the floor. This fitting should be on the side of the brine tank. Most brine tank manufacturers feature a pre-drilled hole for the tank overflow connector.

To connect the overflow line, locate the hole on the side of the tank. Insert the overflow fitting into the tank and tighten with plastic thumb nut and gasket as shown below. Attach a 12.7 mm (1/2”) I.D. tubing (not supplied) to fitting and run to drain.

Do not elevate overflow higher than overflow fitting.



Do not tie into the drain line of the controller unit. The overflow line must be a direct, separate line from overflow fitting to drain, sewer or tub. Allow an air gap as per drain line instructions.

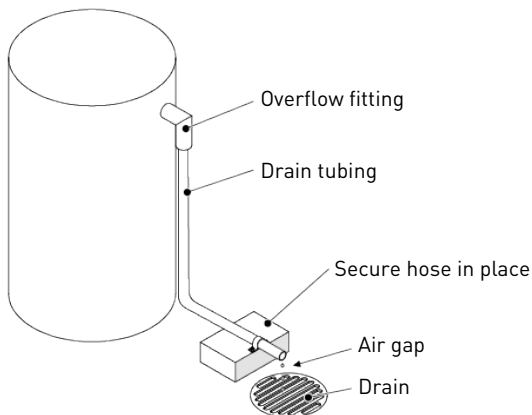

**Caution - material**



**Risk of flooding due to lack of floor drain !**

Floor drain is always recommended to avoid flooding in case of overflow.

**5.13 Brine line connection (Performa 268 - Softener configuration only)**

The brine line connects the valve to the brine tank. Make the connections and hand tighten. Be sure that the brine line is secure and free from air leaks. Even a small leak may cause the brine line to drain out, and the softener will not draw brine from the tank. This may also introduce air into the valve, causing problems with the valve operation.

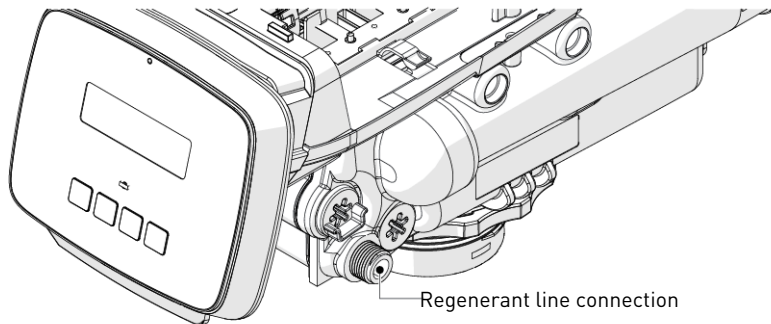

## 6 Programming

### 6.1 Display

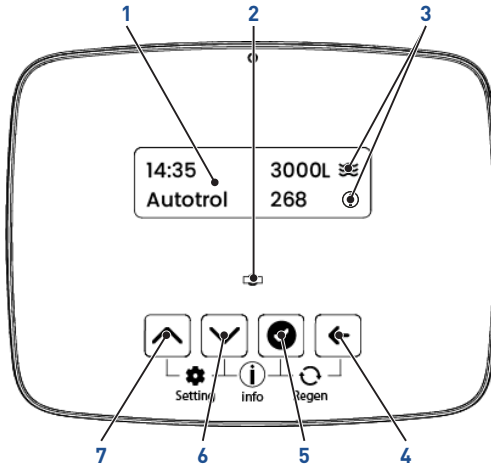

**1. Screen**

- Screen back light changes colors upon valves status:
  - White: In Service /programming (working fine)
  - Blue: Connectivity
  - Green: Regeneration
  - Yellow: minor error
  - Red: major error

**2. Power LED**

**3. Icons**

- Flow: turbine pulses were detected in the last 5 seconds sample period.
- Info: Information screen available by pressing + .

① Amount of mineral in water

Example:

**4. Back button**

**5. Confirm button**

**6. Down button**

**7. Up button**

- Go to previous menu/mode or undo changes on parameters.
- Confirms/saves the displayed value.
- Adjust menu selection/value down.
- Adjust menu selection /value up.

## 6.2 Program structure and navigation

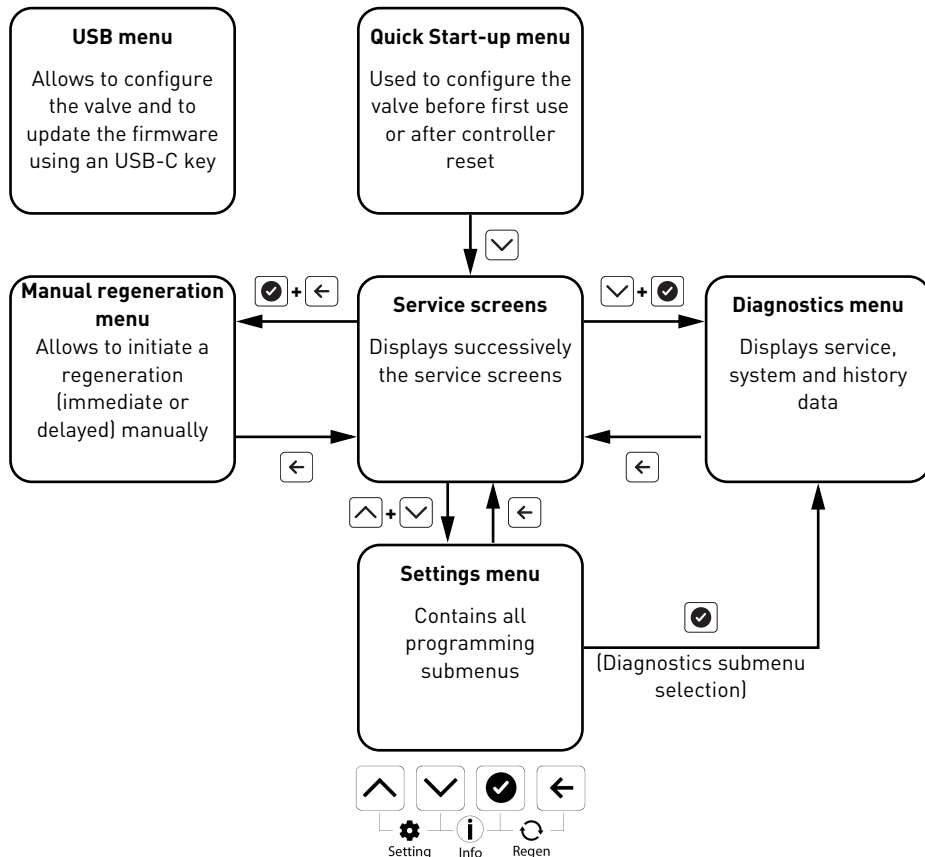

- $\uparrow + \checkmark$  displays **Settings** menu.
- $\downarrow + \checkmark$  displays **Diagnostics** menu.
- $\checkmark + \leftarrow$  displays **Manual regeneration** menu.
- $\leftarrow$  return to **Service** screens.

At first use, the controller displays the **Quick Start-up** menu. Once the initial setup is done, the controller displays the **Service** screens.

From the **Service** screens, it is possible to access the **Manual regeneration** menu, the **Settings** menu and the **Diagnostics** menu and to come back to **Service** screens.

**Diagnostics** menu can also be accessed from **Settings** menu.

### 6.2.1 USB menu structure

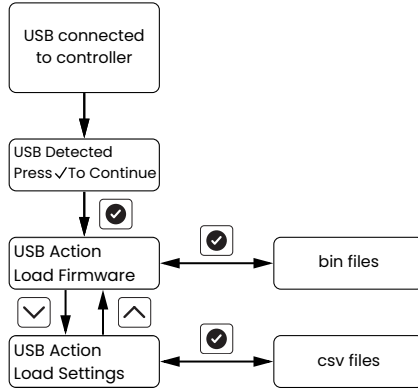

## 6.2.2 Quick Start-up menu structure and navigation

**Info**



**Quick Start-up menu is only accessible at first power on or after controller reset.**

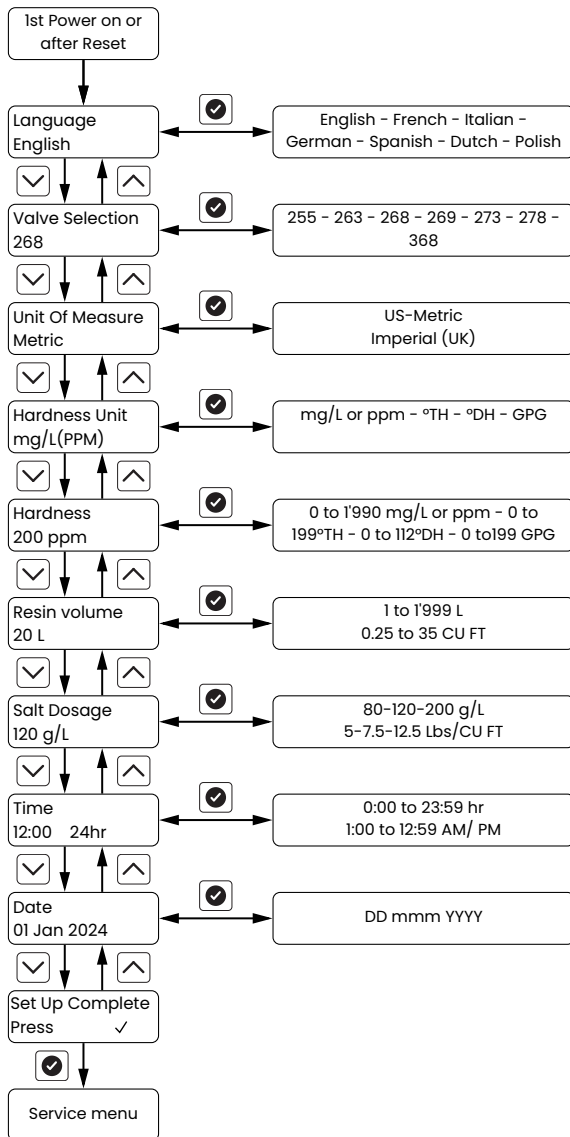

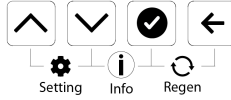

- validate setup parameters and displays **Service** screens.
- displays **Previous** submenu/parameter.
- displays **Next** submenu/parameter.

**Quick Start-up** menu allows to set the main parameters to use the valve. Once parameters are set, the controller goes to **Service** screens.

### 6.2.3 Service menu structure and navigation

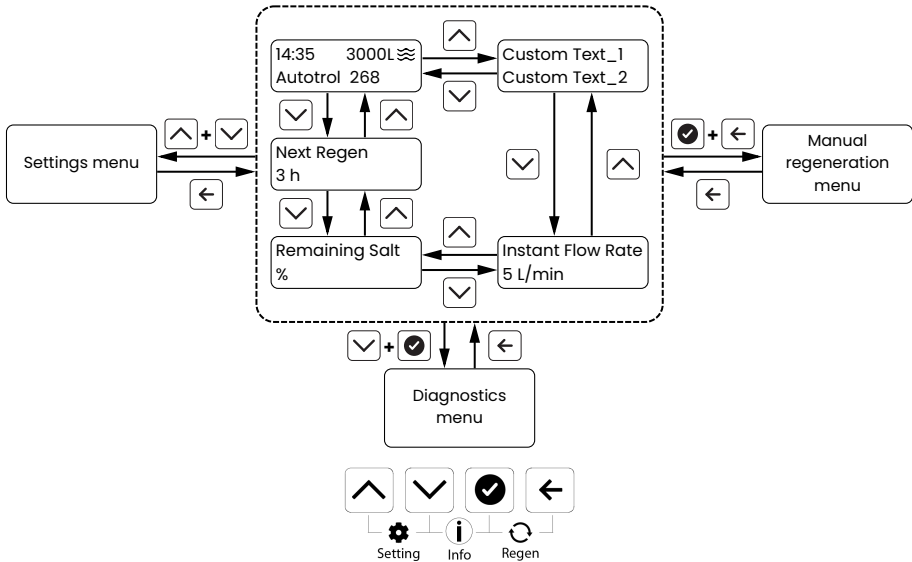

- displays **Settings** Menu.
- displays **Diagnostics** menu.
- displays **Manual regeneration** menu.
- displays **Previous** parameter.
- displays **Next** parameter.
- displays **Service** menu.

In service mode, the controller displays successively the different service information screens. It is also possible to switch manually from one screen to another using the buttons.

It also gives direct access to **Settings**, **Diagnostics** and **Manual regeneration** menus. When coming out of one of these menus, controller comes back to **Service** menu.

## 6.2.4 Settings menu structure and navigation

### Part 1

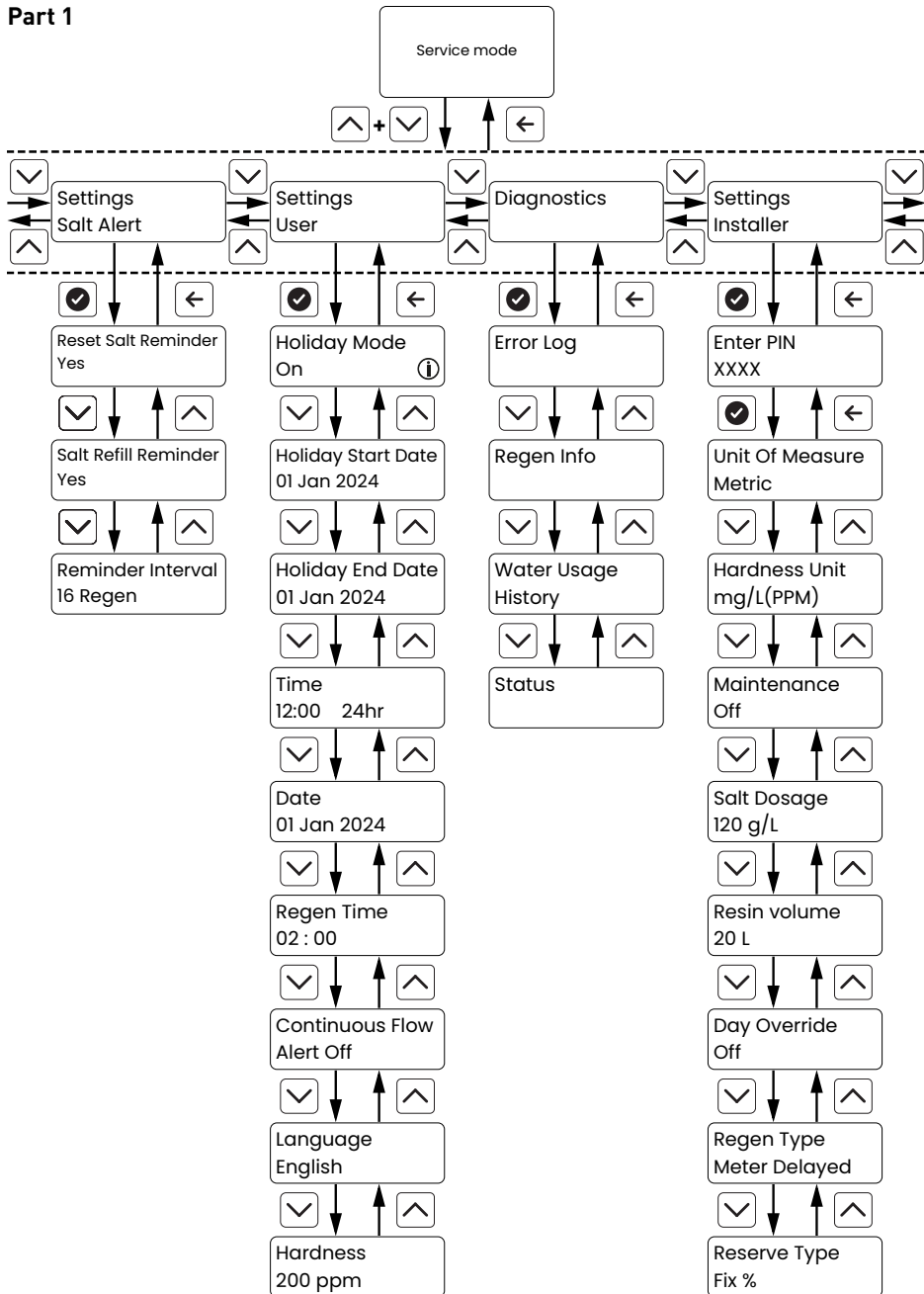

**Part 2**

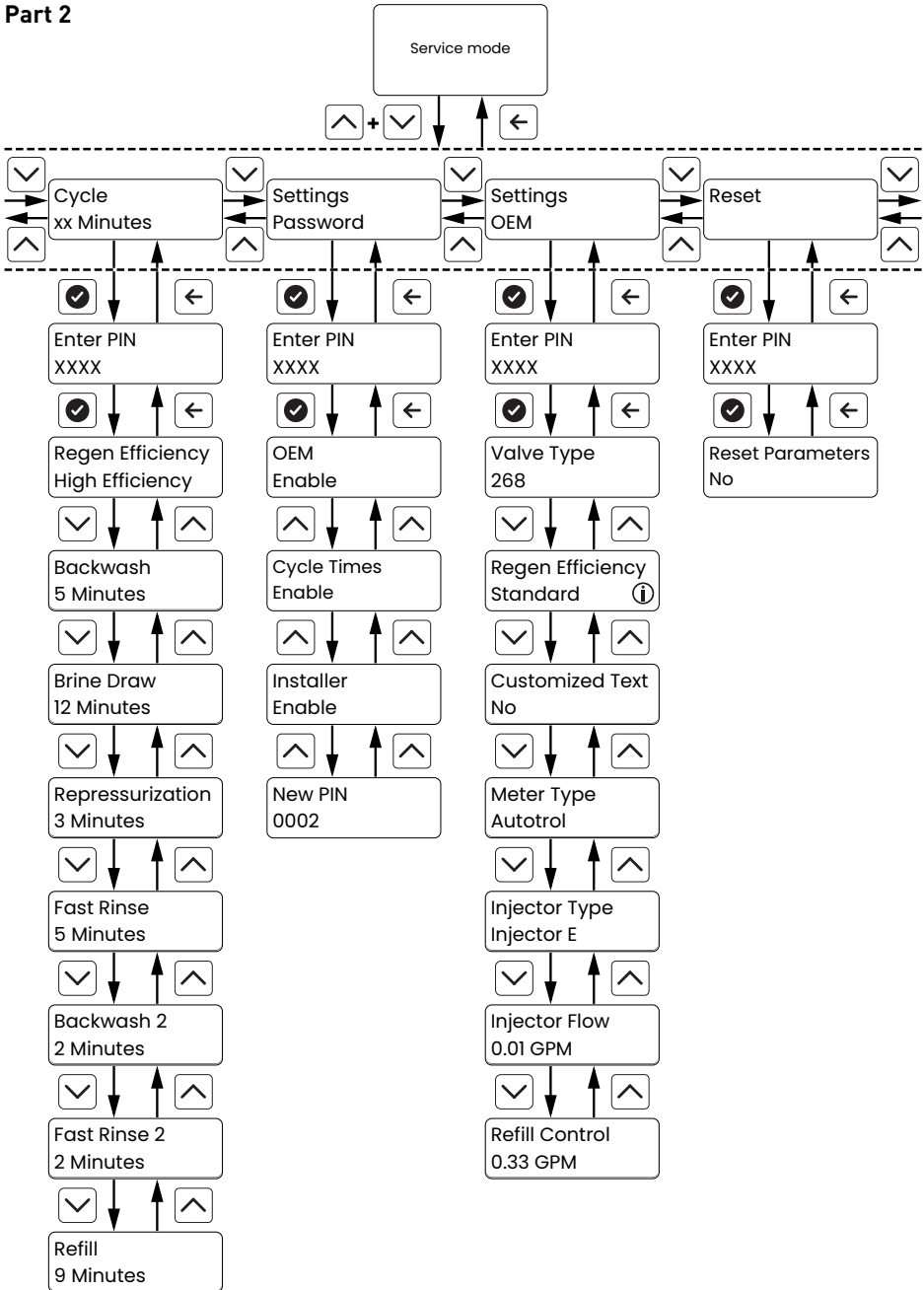



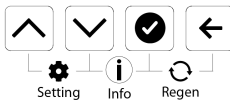

- enter in the menu and validate the PIN.
- displays **Previous** submenu/parameter.
- displays **Next** submenu/parameter.
- goes back from submenu to **Settings** menu, or, from **Settings** menu to **Service** screens.

Settings menu allows to set and check all parameters.

### 6.2.5 Diagnostics menu structure and navigation

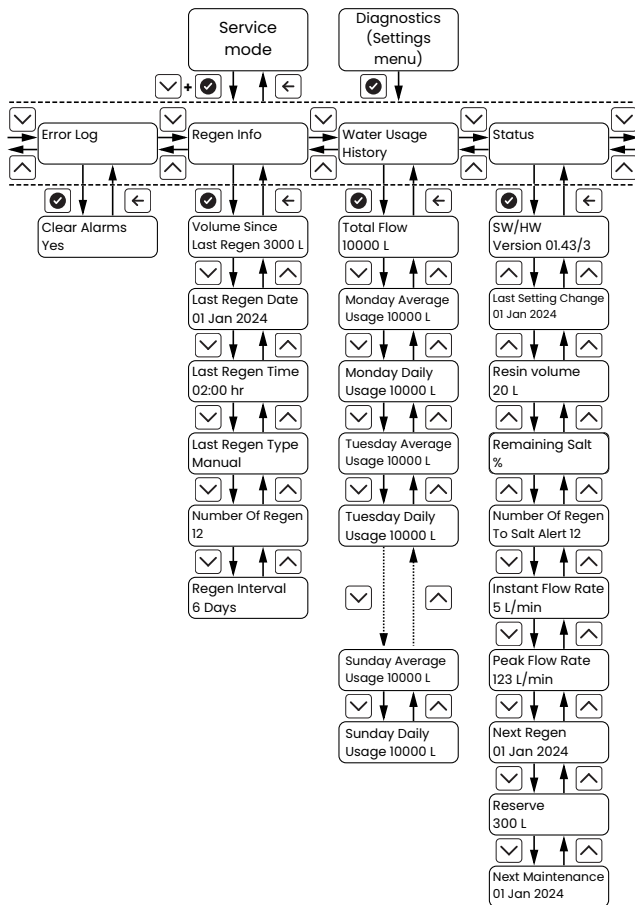

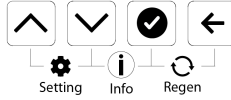

- + displays **Diagnostics** menu from **Service** menu.
- enters **Diagnostics** menu from **Settings** menu, then allowing access to the different **Diagnostics** submenus.
- displays **Previous** submenu/parameter.
- displays **Next** submenu/parameter.
- goes back from submenu to **Diagnostics** menu, or, from **Diagnostics** menu to **Service** menu.

**Diagnostics** menu displays valve usage data.

The menu is accessible directly from **Service** mode or from **Diagnostics** submenu (in **Settings** menu).

### 6.2.6 Manual regeneration menu structure and navigation

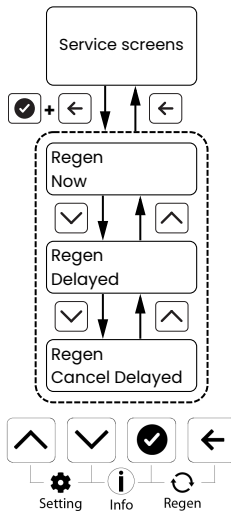

- + displays **Manual regeneration** menu from **Service** screens.
- displays **Previous** parameter.
- displays **Next** parameter.
- goes back to **Service** screens.

**Manual regeneration** menu allows to initiate an immediate regeneration or manage booking of a delayed regeneration.

## 6.3 Parameter setting





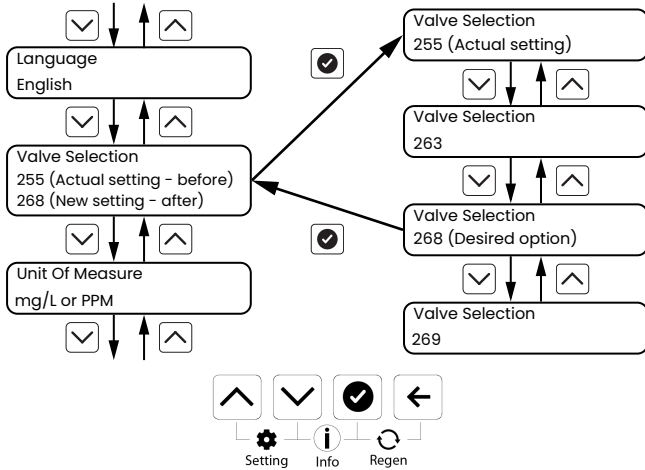

### Info



When a parameter is selected, the editable option is displayed in bold.



The parameters are set the same way for all menus. Once the menu selected, set the menu parameters.

1. Using  and , scroll between the different parameters to select the one to set.
2. Press  to validate the selection.
3. Using  and , scroll between the different values to set the parameter.
4. Press  to validate the setting.
5. Repeat this procedure as needed.
6. Press  to exit the menu.

## 6.4 USB configuration and update

### Info



The Easy-iQ controller can be configured and/or updated with respectively a \*.csv and/or a \*.bin file on an USB-C support.

Options:

- Load firmware
- Load settings

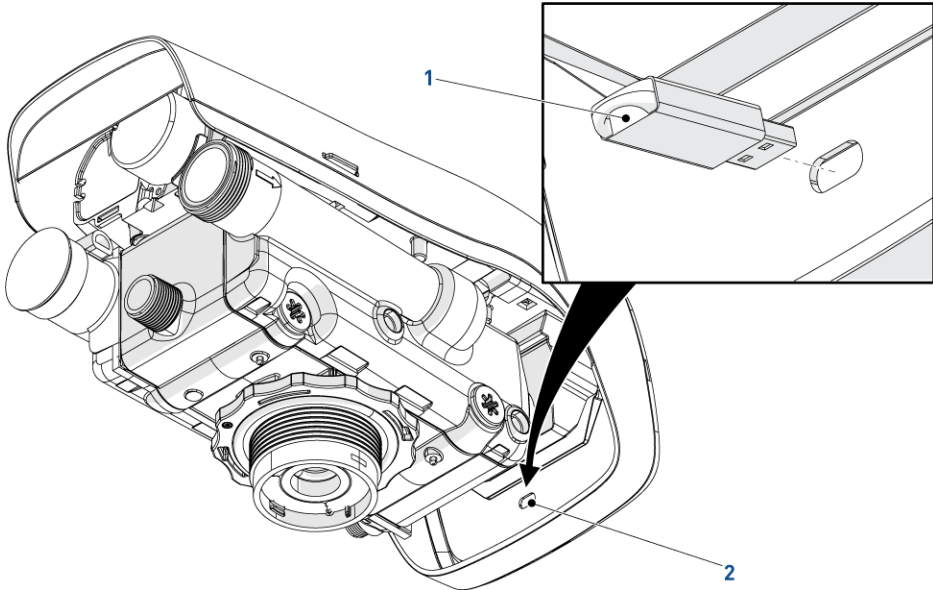

1. Plug the USB-C key **[1]** in the USB connector **[2]**.  
⇒ The USB detected screen is displayed.
2. Press  to enter the **USB setup and update** menu.
3. Using  and , scroll through the different USB actions to select the desired one.
4. Press  to select the USB action.
5. Using  and , scroll through the different possible files to select the file to load.
6. Press  to validate the selection.  
⇒ The file is loaded into the controller and the setting or firmware is replaced by the file content.

USB Detected  
Press ✓ To Continue

USB Action  
Load Settings

Load Settings  
Name\_File.csv

## 6.5 Quick Start-up setup

At start-up or after controller reset, the controller displays the **Quick Start-up** menu. Once **Quick Start-up** is validated, the controller goes in **Service** mode displaying **Service** screens.

### 6.5.1 Quick Start-up mode programming chart

Parameter description	Range of values	Default value	Units of measure	Notes
Language	English French Italian German Spanish Dutch Polish	English	-	-
Valve selection	255 263 268 269 273 278 368	268	-	-
Unit of measure	Metric Imperial (UK) US	Metric	-	-
Hardness unit	mg/l or ppm °TH °dH	mg/l or ppm	-	Metric or Imperial (UK) unit.
	gpg	gpg	-	US unit. Parameter not displayed.
Hardness setting	0 – 199	100	gpg	US unit setting. To be set in the programming tables. Increments of 1 unit.
	0 – 1'990	200	mg/l or ppm	Metric unit setting. Increments of 10 units.
	0 – 199	20	°TH	Metric unit setting.
	0 - 112	12	°dH	Increments of 1 unit.

Parameter description	Range of values	Default value	Units of measure	Notes
Resin amount	1 – 999	20	liter	Metric unit setting. Increments of 1 unit.
	0.25 – 35	1	cubic foot	US or UK unit setting. Increments of 0.25 units.
Salt dosage	Low (80 g/l) Med. (120 g/l) High (200 g/l)	Low (80 g/l)	g/l	Metric unit setting. In Installer Setting menu, it is possible to adjust Salt dosage with increments of 10 g/l of resin for more precise setting.
	Low (5 lb/ft <sup>3</sup> ) Med. (7.5 lb/ft <sup>3</sup> ) High (12.5 lb/ft <sup>3</sup> )	Low (5 lb/ft <sup>3</sup> )	lb/ft <sup>3</sup>	US or UK unit setting. In Installer Setting menu, it is possible to adjust Salt dosage with increments of 0.1 lb/ft <sup>3</sup> of resin for more precise setting.
Set time of day	0:00 – 23:59	00:00	hour: minute	Metric unit setting.
	1:00 – 12:59 AM/ PM	12:00 AM		US unit setting.
Set date	dd/mmm/yyyy	01 Jan 2023	-	-

### 6.5.2 Language

Select the displayed language.

Options:

- English (default);
- French;
- Italian;
- German;
- Spanish;
- Dutch;
- Polish.

1. Press  to select the parameter.
2. Using  and , scroll through the different possible values to select the language.
3. Press  to validate the selection.
4. Press  or  to display the previous/next parameter.

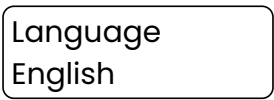

### 6.5.3 Valve type

Select the valve.

Options:

- 368;
- 255;
- 263;
- 268 (default);
- 269;
- 278;
- 273.

1. Press  to select the parameter.
2. Using  and , scroll through the different possible values to select the valve.
3. Press  to validate the selection.
4. Press  or  to display the previous/next parameter.

**Valve Type**  
268

#### 6.5.4 Unit of measure

Select the unit of measure.

Options:

- Metric (default);
- Imperial (UK);
- US.

1. Press  to select the parameter.
2. Using  and , scroll through the different possible values to select the unit of measure.
3. Press  to validate the selection.
4. Press  or  to display the previous/next parameter.

**Unit Of Measure**  
Metric

#### 6.5.5 Hardness unit

##### Info



**This parameter is only displayed when selecting Metric or Imperial.**

If previous selection is US, hardness unit is automatically grains per gallon (gpg).

Select the hardness unit.

Options:

- mg/l or ppm (default);
- °TH;
- °dH.

1. Press  to select the parameter.
2. Using  and , scroll through the different possible values to select the hardness unit.
3. Press  to validate the selection.
4. Press  or  to display the previous/next parameter.

**Hardness Unit**  
 mg/L(PPM)

### 6.5.6 Hardness

Set the inlet water hardness. In case residual hardness at outlet is set using the internal mixing screw, deduct the measured residual hardness from inlet hardness for programming.

US options:

- 0 to 199 GPG (100 default).

Metric options:

- 0 to 1'990 mg/l or ppm (200 default);
- 0 to 199 °TH (20 default);
- 0 to 112 °dH (12 default).

1. Press  to select the parameter.
2. Using  and , scroll through the different possible values to set the inlet water hardness.
3. Press  to validate the setting.
4. Press  or  to display the previous/next parameter.

**Hardness Setting**  
 200 mg/L(PPM)

### 6.5.7 Resin volume

Set the system resin amount.

US and UK options:

- 0.25 to 35 ft<sup>3</sup> (1 default);

Metric options:

- 0 to 1'999 l (20 default).

1. Press  to select the parameter.
2. Using  and , scroll through the different possible values to set the resin amount.
3. Press  to validate the setting.
4. Press  or  to display the previous/next parameter.

**Resin volume**  
 20 L

### 6.5.8 Salt dosage

Set the salt dosage.







US options:



- 3 to 18 lbs/ft<sup>3</sup> (Default, quick start-up menu programmed value);

Metric options:

- 50 to 290 g/l (Default, quick start-up menu programmed value);

1. Press  to select the parameter.
2. Using  and , scroll through the different possible values to set the salt dosage.
3. Press  to validate the setting.
4. Press  or  to display the previous/next parameter.

Salt Dosage  
120 g/L

### 6.5.9 Time







Set the time of day.

US and UK options:

- 01:00 AM to 12:25 PM (12:00 AM default).

Metric options:

- 00:00 to 24:00 (00:00 default).

1. Press  to select the parameter.
2. Using  and , scroll through the different possible values to set the time hour.
3. Press  to validate the hour setting.
4. Repeat the previous two steps to set the time minutes.
5. Press  or  to display the previous/next parameter.

Time  
12:00 24hr







### 6.5.10 Date

Set the date dd/mmm/yyyy.

Options:

- dd  
01 to 31.
- mmm  

Jan;	Apr;	Jul;	Oct;
Feb;	May;	Aug;	Nov;
Mar;	Jun;	Set;	Dec.
- yyyy  
2023 to 9999.

1. Press  to select the parameter.
2. Using  and , scroll through the different possible values to set the day.
3. Press  to validate day setting.
4. Repeat the previous two steps once to set the month and a second time to set the year.
5. Press  or  to display the previous/next parameter.

Date  
 01 Jan 2024

### 6.5.11 Quick Start-up completed

#### Info



Once quick start-up parameters are set, this menu can be displayed again only following to a controller reset.

Save the **Quick Start-up** menu programming and display normal **Service** mode.

1. If necessary, press  to display the previous parameter.
2. Press  to save **Quick Start-up** and to display **Service** mode.

Set Up Complete  
 Press 







## 6.6 Settings menu

### 6.6.1 Submenu selection

Select the desired submenu.

Submenus:

- Salt alert;
- User;
- Diagnostic;
- Installer;
- Cycle time;
- PIN code;
- OEM;
- Reset.

1. If necessary, press  to come back to **Service** screens.
2. Press  +  to display **Settings** menus.
3. Using  and , scroll between the different submenus to select the one to set.
4. Press  to validate the selection.
5. Set the desired parameters.  
⇒ Refer to Parameter setting [→Page 55].
6. Press  to come back to **Settings** menu.

**Service screen**

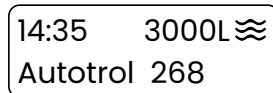

**Settings menu (i.e. User)**

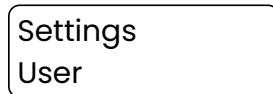

## 6.6.2 Alert setting menu

### 6.6.2.1 Alert setting menu programming chart







Parameter	Values	Notes
Reset salt rem.	Yes No	Resets the regeneration counter.
Salt refill rem.	Yes No	If activated, alerts the user after xx regenerations.
Reminder interval	1 to 99	Set the number of regenerations to trigger an alert. Only displayed if Salt refill rem. is <b>Yes</b> . Increments of 1 unit.

### 6.6.2.2 Reset salt reminder

Reset the salt reminder interval to the initially programmed value. This should be done each time the brine tank is filled with salt to its maximum.

Options:

- Yes (Default);
- No.

1. Press  to select the parameter.
2. Using  and , scroll through the different possible values to select the option.
3. Press  to validate the selection.
4. Press  or  to display the previous/next parameter.



### 6.6.2.3 Salt refill reminder

Activate the salt refill reminder.

Options:

- Yes;

- No (Default).

1. Press  to select the parameter.
2. Using  and , scroll through the different possible values to activate/deactivate the reminder.
3. Press  to validate the selection.
4. Press  or  to display the previous/next parameter.

Salt Refill Reminder  
Yes

#### 6.6.2.4 Salt refill reminder interval

Set the interval of regeneration to trigger a salt refill reminder.

Options:

- 0 to 99 regenerations (16 default).
1. Press  to select the parameter.
  2. Using  and , scroll through the different possible values to set the interval.
  3. Press  to validate the setting.
  4. Press  or  to display the previous/next parameter.

Reminder Interval  
16 Regen

### 6.6.3 User setting menu

#### 6.6.3.1 User setting menu programming chart

Parameter description	Range of values	Default value	Units of measure	Notes
Holiday mode	Off On	Off	-	-
Holiday start date	dd/mmm/yyyy	Today	-	-
Holiday end date	dd/mmm/yyyy	Today	-	-
Time of day	0:00 - 23:59	00:00	hour: minute	Metric unit setting.
	1:00 - 12:59 AM/ PM	12:00 AM		US unit setting.
Date	dd/mmm/yyyy	01 Jan 2023	-	-
Regen. time	0:00 - 23:59	02:00	hour: minute	Metric unit setting.
	1:00 - 12:59 AM/ PM	02:00 AM		US unit setting.

Parameter description	Range of values	Default value	Units of measure	Notes
Contin. Flow alert	Off On	Off	-	If activated, alerts the user after xx hours of continuous flow. 1 to 12 with increments of 1. Only if there is a continuous flow of more than 1 l/min or 0.25 gpm default (value can be adjusted). The alarm is triggered if the flow stays above this value for the set time value.
Language	English French Italian German Spanish Dutch Polish	English	-	-
Hardness	0 – 199	100	gpg	US unit setting. To be set in the programming tables. Increments of 1 unit.
	0 – 1'990	200	mg/l or ppm	Metric unit setting. Increments of 10 units.
	0 – 199	20	°TH	Metric unit setting.
	0 – 112	12	°dH	Increments of 1 unit.

### 6.6.3.2 Holiday mode

#### Info



The Holiday mode option has two main advantages:

**It reduces energy, water and salt consumption when your softener is not used for an extended period of time as it prevents unnecessary regeneration cycles.**

**It keeps the system in safety condition. At holiday start date, the valve initiates a regeneration and stops after brine draw cycle, isolating the media tank from piping to prevent bacteria growth during absence. Before holiday end date, the system will rinse the media tank removing the brine.**

Activate the holiday mode to stop regeneration when travelling.

Options:

- Off (Default);
- On.

1. Press to select the parameter.
2. Using and , scroll through the different possible values to activate/deactivate the holiday mode.
3. Press to validate the selection.
4. Press or to display the previous/next parameter.

Holiday Mode  
On

### 6.6.3.3 Holiday mode start date

**Info**



This parameter is displayed only if Holiday mode is On.

**Info**



The default date is today.

Set the date (dd/mmm/yyyy) of the holiday mode start.

Options:

- dd  
01 to 31.
- mmm

Jan;	Apr;	Jul;	Oct;
Feb;	May;	Aug;	Nov;
Mar;	Jun;	Set;	Dec.

- yyyy  
2023 to 9999.

1. Press to select the parameter.
2. Using and , scroll through the different possible values to set the day.
3. Press to validate day setting.
4. Repeat the previous two steps once to set the month and a second time to set the year.
5. Press or to display the previous/next parameter.

Holiday Start Date  
01 Jan 2024

### 6.6.3.4 Holiday mode end date

**Info**



This parameter is displayed only if Holiday mode is On.

Info



**The default date is today.**

Set the date (dd/mmm/yyyy) of the holiday mode end.

Options:

- dd  
01 to 31.
- mmm
 

Jan;	Apr;	Jul;	Oct;
Feb;	May;	Aug;	Nov;
Mar;	Jun;	Set;	Dec.
- yyyy  
2023 to 9999.

1. Press  to select the parameter.
2. Using  and , scroll through the different possible values to set the day.
3. Press  to validate day setting.
4. Repeat the previous two steps once to set the month and a second time to set the year.
5. Press  or  to display the previous/next parameter.

**Holiday End Date**  
01 Jan 2024

**6.6.3.5 Time**

Set the time of day.

US and UK options:

- 01:00 AM to 12:25 PM (12:00 AM default).

Metric options:

- 00:00 to 24:00 (00:00 default).

1. Press  to select the parameter.
2. Using  and , scroll through the different possible values to set the time hour.
3. Press  to validate the hour setting.
4. Repeat the previous two steps to set the time minutes.
5. Press  or  to display the previous/next parameter.

**Time**  
12:00 24hr

**6.6.3.6 Date**

Set the date dd/mmm/yyyy.

Options:

- dd  
01 to 31.
- mmm

Jan;	Apr;	Jul;	Oct;
Feb;	May;	Aug;	Nov;
Mar;	Jun;	Set;	Dec.

- yyyy  
2023 to 9999.

1. Press  to select the parameter.
2. Using  and , scroll through the different possible values to set the day.
3. Press  to validate day setting.
4. Repeat the previous two steps once to set the month and a second time to set the year.
5. Press  or  to display the previous/next parameter.

Date  
01 Jan 2024

#### 6.6.3.7 Regeneration time

Set the regeneration time.

US and UK options:

- 01:00 AM to 12:25 PM (02:00 AM default).

Metric options:

- 00:00 to 24:00 (02:00 default).

1. Press  to select the parameter.
2. Using  and , scroll through the different possible values to set the regeneration time hour.
3. Press  to validate the hour setting.
4. Repeat the previous two steps to set the regeneration time minutes.
5. Press  or  to display the previous/next parameter.

Regen Time  
02 : 00

#### 6.6.3.8 Continuous flow alert

##### Info



**To trigger this alert, a minimum flow rate of 1 l/min or 0.25 gpm (default values, adjustable) is needed for the programmed duration. The alarm is triggered if the flow stays above this value for the set delay.**

Activate the continuous flow alert.









Options:

- On;
- Off (Default).

Delay options:

- 1 to 12 hours (1 default).

1. Press  to select the parameter.
2. Using  and , scroll through the different possible values to activate/deactivate the continuous flow alert.
3. Press  to validate the selection.
4. Repeat the previous two steps once to set the minimum flow rate to trigger an alarm and a second time to set the alert delay.
5. Press  or  to display the previous/next parameter.

**Continuous flow alert activation**

Continuous Flow  
Alert Off

**Flow trigger setting**

Cont. Flow Trigger  
1 L/min

**Delay setting**







Flow Alert Delay  
1 Hour

#### 6.6.3.9 Language

Select the displayed language.

Options:

- English (default);
- French;
- Italian;
- German;
- Spanish;
- Dutch;
- Polish.

1. Press  to select the parameter.
2. Using  and , scroll through the different possible values to select the language.
3. Press  to validate the selection.
4. Press  or  to display the previous/next parameter.

Language  
English

### 6.6.3.10 Hardness







Set the inlet water hardness. In case residual hardness at outlet is set using the internal mixing screw, deduct the measured residual hardness from inlet hardness for programming.

US options:

- 0 to 199 GPG (100 default).

Metric options:

- 0 to 1'990 mg/l or ppm (200 default);
- 0 to 199 °TH (20 default);
- 0 to 112 °dH (12 default).

1. Press  to select the parameter.
2. Using  and , scroll through the different possible values to set the inlet water hardness.
3. Press  to validate the setting.
4. Press  or  to display the previous/next parameter.

Hardness Setting  
200 mg/L (PPM)

### 6.6.4 Diagnostic menu

Refer to Diagnostic menu [→Page 91].

## 6.6.5 Installer setting menu

### 6.6.5.1 Installer setting menu programming chart

Parameter description	Range of values	Default value	Units of measure	Notes
Unit of measure	Metric Imperial (UK) US	Metric	-	-
Hardness unit	mg/l or ppm °TH °dH	mg/l or ppm	-	Metric or Imperial (UK) unit.
	gpg	gpg	-	US unit. Parameter not displayed.
Maintenance interval	Off 1 to 48	Off	month	-
Salt dosage	50 to 290	Setup value	g/l	Increments of 10 g/l.
	3 to 18		lbs/ft <sup>3</sup>	Increments of 1 lbs/ft <sup>3</sup> .
Resin volume	1 – 999	20	liter	Metric unit setting. Increments of 1 unit.
	0.25 – 35	1	cubic foot	US or UK unit setting. Increments of 0.25 units.
Day override	Off 6 or 12 1 to 30	Off	- hour day	-
Reserve type	Fixed % 1 to 50	1	%	Increments of 1 unit.
	Fixed volume 1 to xxx	1	l gal	xxx is calculated (max.50% of the volume capacity).
	Variable reserve	30% of the initial capacity.	l gal	Daily updated based upon the real water consumption taking into account the day of week over the past 4 weeks history of daily water consumptions.

Parameter description	Range of values	Default value	Units of measure	Notes
Regen. Start	Time clock immediate Time clock delayed Time clock day of the week Meter immediate Meter delayed	Time clock immediate	-	-
Time clock immediate regeneration start parameters				
Day interval	1 to 99	1	day	-
Time clock delayed regeneration start parameters				
Day interval	1 to 99	1	day	-
Remote regeneration	On Off	Off	-	In time clock mode the water meter input can be used as a remote start input.
Remote regeneration delay	1 to 60	1	second	Duration of the input signal to trigger the remote regeneration.
Time clock day of the week regeneration start parameters				
Monday	On Off	Off	-	In this mode the regeneration starts at the regeneration time ex. 2:00 am on the days set to On.
Tuesday	On Off	Off	-	
Wednesday	On Off	Off	-	
Thursday	On Off	Off	-	
Friday	On Off	Off	-	
Saturday	On Off	Off	-	
Sunday	On Off	Off	-	
Meter immediate regeneration start parameters				

Parameter description	Range of values	Default value	Units of measure	Notes
Capacity	3 to 9	3	°THxm <sup>3</sup> /l	Increments of 0.01 °THxm <sup>3</sup> /l.
	1.8 to 5	1.8	°dHxm <sup>3</sup> /l	Increments of 0.01 °dHxm <sup>3</sup> /l.
	30 to 90	30	g/l eq. CaCO <sub>3</sub>	Increments of 0.1 g/l eq. CaCO <sub>3</sub> .
	0 to 999'999	0	l	Only for 263 in European units. Increments of 1 l.
	10'000 to 40'000	10'000	grains/ft <sup>3</sup>	Increments of 1 grain/ft <sup>3</sup> .
	0 to 999'999	0	gal	Only for 263 in US units. Increments of 1 gal.
Meter delayed regeneration start parameters				
Capacity	3 to 9	3	°THxm <sup>3</sup> /l	Increments of 0.01 °THxm <sup>3</sup> /l.
	1.8 to 5	1.8	°dHxm <sup>3</sup> /l	Increments of 0.01 °dHxm <sup>3</sup> /l.
	30 to 90	30	g/l eq. CaCO <sub>3</sub>	Increments of 0.1 g/l eq. CaCO <sub>3</sub> .
	0 to 999'999	0	l	Only for 263 in European units. Increments of 1 l.
	10'000 to 40'000	10'000	grains/ft <sup>3</sup>	Increments of 1 grain/ft <sup>3</sup> .
	0 to 999'999	0	gal	Only for 263 in US units. Increments of 1 gal.
Remote regeneration	On Off	Off	-	In time clock mode the water meter input can be used as a remote start input.
Remote regeneration delay	1 to 60	1	second	Duration of the input signal to trigger the remote regeneration.

### 6.6.5.2 Installer setting menu access







#### Info



**Access to this menu is PIN code protected.**

Refer to PIN code settings menu [→Page 84].

If prompted, enter the PIN code (1201 default) and validate.

1. Press  to start entering the PIN code.
2. Using  and , scroll through the different possible values to set the 1<sup>st</sup> PIN digit.
3. Press  to validate the 1<sup>st</sup> PIN digit setting.
4. Repeat the two previous steps to set the next three PIN digits.
5. Press  or  to display the parameters.







Enter PIN  
XXXX

### 6.6.5.3 Unit of measure

Select the unit of measure.

Options:

- Metric (default);
- Imperial (UK);
- US.

1. Press  to select the parameter.
2. Using  and , scroll through the different possible values to select the unit of measure.
3. Press  to validate the selection.
4. Press  or  to display the previous/next parameter.

Unit Of Measure  
Metric

### 6.6.5.4 Hardness unit

#### Info



**This parameter is only displayed when selecting Metric or Imperial.**

If previous selection is US, hardness unit is automatically grains per gallon (gpg).

Select the hardness unit.

Options:

- mg/l or ppm (default);
- °TH;
- °dH.

1. Press  to select the parameter.
2. Using  and , scroll through the different possible values to select the hardness unit.
3. Press  to validate the selection.
4. Press  or  to display the previous/next parameter.

**Hardness Unit**  
mg/L(PPM)

#### 6.6.5.5 Maintenance interval

Set the maintenance interval. When reached, displays a maintenance alert.

Options:

- Off (Default);
- 1 to 48 months.

1. Press  to select the parameter.
2. Using  and , scroll through the different possible values to set the maintenance interval.
3. Press  to validate the setting.
4. Press  or  to display the previous/next parameter.

**Maintenance**  
Off

#### 6.6.5.6 Salt dosage

Set the salt dosage.

US options:

- 3 to 18 lbs/ft<sup>3</sup> (Default, quick start-up menu programmed value);

Metric options:

- 50 to 290 g/l (Default, quick start-up menu programmed value);

1. Press  to select the parameter.
2. Using  and , scroll through the different possible values to set the salt dosage.
3. Press  to validate the setting.
4. Press  or  to display the previous/next parameter.

**Salt Dosage**  
120 g/L

#### 6.6.5.7 Resin volume







Set the system resin volume.

Metric options:

- 0 to 999 l (Default, quick start-up menu programmed value).

US and UK options:

- 0.25 to 35 ft3 (Default, quick start-up menu programmed value);







1. Press  to select the parameter.
2. Using  and , scroll through the different possible values to set the resin volume.
3. Press  to validate the setting.
4. Press  or  to display the previous/next parameter.

Resin volume  
20 L

### 6.6.5.8 Day override

Set the maximum durations (hours or days) between two regenerations before the **Day override** regeneration is booked.

- Off (Default);
- 6 hours;
- 12 hours;
- 1 to 30 days.

1. Press  to select the parameter.
2. Using  and , scroll through the different possible values to set the day override.
3. Press  to validate the setting.
4. Press  or  to display the previous/next parameter.

Day Override  
Off

### 6.6.5.9 Reserve type

#### Info



**Reserve type is displayed only if meter immediate or delayed is selected.**

Select and set the reserve type.

- Fixed % (1 to 50%, 1 default) (Default);
- Fixed volume (1 to the half of the calculated unit capacity);
- Variable reserve;
- Weekly reserve.



1. Press  to select the parameter.
2. Using  and , scroll through the different possible values to select the reserve type.
3. Press  to validate the selection.
4. If needed, using  and , scroll through the different possible values to set the reserve.
5. Press  to validate the selection.
6. Press  or  to display the previous/next parameter.

**Reserve type selection**

**Reserve Type**  
 Fix %

**Reserve setting**

**Fixed %**  
 1 %

### 6.6.5.10 Regeneration start

Select and set the regeneration initiation mode.

- Time clock;
- Time clock Day of the week;
- Meter immediate;
- Meter delayed (Default).

#### Time clock

Set the interval (days) between two regenerations. The regeneration starts at the programmed regeneration time.

In this mode, the regeneration can also be initiated via remote dry contact signal on the turbine input connector. In this case **Remote regeneration** should be set to **On** and the remote signal switch to the desired duration (1-60 seconds).

Remote regeneration:

- On;
- Off (Default).

Remote signal switch delay:

- 1 to 60 seconds (1 default).

1. Press to select the parameter.
2. Using and , scroll through the different possible values to select the time clock regeneration interval.
3. Press to validate the selection.
4. If needed, using and , scroll through the different possible values to activate/deactivate the remote regeneration.
5. Press to validate the selection.
6. If remote regeneration is activated, using and , scroll through the different possible values to set the remote regeneration delay.
7. Press to validate the setting.
8. Press or to display the previous/next parameter.

**Regeneration initiation mode**

Regen Start  
Time Clock

**Remote regeneration selection**

Remote Regen  
On

**Remote regeneration delay setting**

Remote Regen  
Delay 1 Second

**Time clock Day of the week**

**Mandatory**



**In this mode, at least one day must be set to on!**

When this mode is selected default is **On** for all days. The regeneration starts at the programmed regeneration time for each activated days of the week.

Day override parameter is ignored when time clock day of the week is selected.

Activate/deactivate regeneration initiation for each day:

Regeneration days:

- Monday On/Off;
- Tuesday On/Off;
- Wednesday On/Off;
- Thursday On/Off;
- Friday On/Off;
- Saturday On/Off;
- Sunday On/Off.

1. Press  to select the parameter.
2. Using  and , scroll through the different possible values to select the time clock day of the week regeneration mode.
3. Press  to validate the selection.
4. Repeat the previous two steps once to select a regeneration day and a second time to set day to **On**.
5. Repeat the three last points of this procedure as needed.
6. Press  or  to display the previous/next parameter.

**Regeneration initiation mode**

Regen Start  
Day Of The Week

**Day of the week selection**

Day Of The Week  
Monday

**Regeneration activated on selected day**

Monday  
On

**Meter immediate**

**Info**



**The exchange capacity is precalculated based on salt dosage as for high or standard efficiency exchange capacity table.**

**The exchange capacity displayed depends on the chosen system unit.**

Select the meter immediate regeneration mode and set the exchange capacity per unit of resin volume (l or ft<sup>3</sup> depending on chosen unit of measures).

Metric:

- °THxm<sup>3</sup>/l (3 to 9);
- °dHxm<sup>3</sup>/l (1.8 to 5);
- g/l eq. CaCO<sub>3</sub> (30 to 90);
- Valve 263 (0 to 999'999);

US:

- grains/ft<sup>3</sup> (10'000 to 40'000);
- Valve 263 (0 to 999'999);

1. Press  to select the parameter.
2. Using  and , scroll through the different possible values to select the meter immediate regeneration mode.
3. Press  to validate the selection.
4. Repeat the previous two steps to set the exchange capacity.
5. Press  or  to display the previous/next parameter.

**Regeneration initiation mode**

Regen Start  
Meter Immediate

**Exchange capacity setting**

Exchange Capacity  
5.00 °THxm<sup>3</sup>/L

## Meter delayed

### Info



The exchange capacity is precalculated based on salt dosage as for high or standard efficiency exchange capacity table.

The exchange capacity displayed depends on the chosen system unit.

Select the meter delayed regeneration mode and set the exchange capacity per unit of resin volume (l or ft<sup>3</sup> depending on chosen unit of measures).

Metric:

- °THxm<sup>3</sup>/l (3 to 9);
- °dHxm<sup>3</sup>/l (1.8 to 5);
- g/l eq. CaCO<sub>3</sub> (30 to 90);
- Valve 263 (0 to 999'999);

US:

- grains/ft<sup>3</sup> (10'000 to 40'000);
- Valve 263 (0 to 999'999);

1. Press  to select the parameter.
2. Using  and , scroll through the different possible values to select the meter delayed regeneration mode.
3. Press  to validate the selection.
4. Repeat the previous two steps to set the exchange capacity.
5. Press  or  to display the previous/next parameter.

**Regeneration start selection**

Regen Type  
Meter Delayed

**Exchange capacity setting**

Exchange Capacity  
5.00 °THxm<sup>3</sup>/L

## 6.6.6 Cycle time setting menu

### 6.6.6.1 Regeneration cycle time programming chart

### Info



Cycle time sequence depends on regeneration mode programming.

Parameter description	Range of values	Default value	Units of measure	Notes
Regen. mode	High efficiency STD efficiency	STD efficiency	-	High efficiency is displayed only with 268. 263 is automatically set to STD efficiency.
High efficiency for 268				
Backwash	0 to 99	5	minute	Increments of 1 minute.

Parameter description	Range of values	Default value	Units of measure	Notes
Brine draw	0 to 240	-	minute	Calculated.
Slow rinse	0 to 240	30	Minute	Increments of 1 minute.
Repressurization	1 to 3	1	minute	Increments of 1 minute.
Fast rinse	0 to 99	6	minute	Increments of 1 minute.
Backwash #2	0 to 99	1	minute	Increments of 1 minute.
Fast rinse #2	0 to 99	1	minute	Increments of 1 minute.
Brine refill	0 to 240	-	minute	Calculated.
Standard efficiency for 263				
Backwash	0 to 99	15	minute	Increments of 1 minute.
Repressurization	1 to 3	1	minute	Increments of 1 minute.
Fast rinse	0 to 99	6	minute	Increments of 1 minute.
Standard efficiency for 268				
Backwash	0 to 99	5	minute	Increments of 1 minute.
Brine draw	0 to 240	-	minute	Calculated.
Slow rinse	0 to 240	30	Minute	Increments of 1 minute.
Repressurization	1 to 3	1	minute	Increments of 1 minute.
Fast rinse	0 to 99	6	minute	Increments of 1 minute.
Brine refill	0 to 240	-	minute	Calculated.

### 6.6.6.2 Cycle time setting menu access

#### Info



**Access to this menu is PIN code protected.**

Refer to PIN code settings menu [→Page 84].

If prompted, enter the PIN code (1201 default) and validate.

1. Press to start entering the PIN code.
2. Using and , scroll through the different possible values to set the 1<sup>st</sup> PIN digit.
3. Press to validate the 1<sup>st</sup> PIN digit setting.
4. Repeat the two previous steps to set the next three PIN digits.
5. Press or to display the parameters.

Enter PIN  
XXXX

### 6.6.6.3 Regeneration mode

#### Info



**For 263 valve, the regeneration mode will always be standard and will not be displayed.**

Set the regeneration mode.

Regeneration mode options for 268:

- High efficiency;
- Standard (Default).

1. Press to select the parameter.
2. Using and , scroll through the different possible values to select the regeneration mode.
3. Press to validate the selection.
4. Press or to display the previous/next parameter.

Regen Efficiency  
Standard

#### 6.6.6.4 Cycle times

##### Info



The displayed cycle times depends on valve configuration.

Set all the cycle times.

Cycle time options:

- Refer to Regeneration cycle time programming chart [[->Page 80](#)].

##### Tip



To skip a cycle, set the cycle time to 0.

1. Press to select the parameter.
2. Using and , scroll through the different possible values to set the cycle time.
3. Press to validate the setting.
4. Press or to display the previous/next cycle time.
5. Repeat this procedure as needed.

Cycle  
xx Minutes

#### 6.6.7 PIN setting menu

##### 6.6.7.1 PIN setting menu programming chart

Parameter description	Range of values	Default value	Units of measure	Notes
OEM settings	Enable Disable	Enable	-	-
Cycle time settings	Enable Disable	Enable	-	-

Parameter description	Range of values	Default value	Units of measure	Notes
Installer settings	Enable Disable	Enable	-	-
New PIN	0000 to 9999	1201	-	-

### 6.6.7.2 PIN code setting menu access

#### Info



**Access to this menu is PIN code protected.**

Refer to PIN code settings menu [→Page 84].

If prompted, enter the PIN code (1201 default) and validate.

1. Press  to start entering the PIN code.
2. Using  and , scroll through the different possible values to set the 1<sup>st</sup> PIN digit.
3. Press  to validate the 1<sup>st</sup> PIN digit setting.
4. Repeat the two previous steps to set the next three PIN digits.
5. Press  or  to display the parameters.

Enter PIN  
XXXX

### 6.6.7.3 OEM PIN setting

Activate PIN for OEM setting access.

- Enable (Default);
  - Disable.
1. Press  to select the parameter.
  2. Using  and , scroll through the different possible values to activate/deactivate the PIN for OEM setting access.
  3. Press  to validate the setting.
  4. Press  or  to display the previous/next parameter.

OEM  
Enable

### 6.6.7.4 Cycle time PIN setting

Activate PIN for cycle time setting access.

- Enable (Default);
- Disable.

1. Press  to select the parameter.
2. Using  and , scroll through the different possible values to activate/deactivate the PIN for cycle time setting access.
3. Press  to validate the setting.
4. Press  or  to display the previous/next parameter.

Cycle Times  
Enable

#### 6.6.7.5 Installer PIN setting

Activate PIN for installer settings access.

- Enable (Default);
- Disable.

1. Press  to select the parameter.
2. Using  and , scroll through the different possible values to activate/deactivate the PIN for installer setting access.
3. Press  to validate the setting.
4. Press  or  to display the previous/next parameter.

Installer  
Enable

#### 6.6.7.6 PIN code settings menu

Set a new PIN.

PIN options:

- 0000 to 9999 (1201 default).

1. Press  to select the parameter.
2. Using  and , scroll through the different possible values to set the 1<sup>st</sup> PIN digit.
3. Press  to validate the 1<sup>st</sup> PIN digit setting.
4. Repeat the two previous steps to set the next three PIN digits.
5. Press  or  to display the parameters.

New PIN  
0002



## 6.6.8 OEM setting menu

### 6.6.8.1 OEM setting menu programming chart

Parameter description	Range of values	Default value	Units of measure	Notes
Valve type	368 255 263 268 269 278 273	268	-	-
Reg efficiency	High Standard	Standard	-	-
Customized text	No Yes	No	-	Up to 16 characters/numbers per line. 2 lines max.
Meter type	Autotrol Kfactor Pulse equivalent	Autotrol	-	-
Injector type	Injector E Injector F Injector G Injector H Injector I Injector K Injector L Injector M Injector N Injector O Injector Q Injector R	-	-	Automatically chosen upon the programmed volume of resin. If needed, this parameter setting can be overridden by the OEM/installer.
Injector flow	Brine draw 0.01 to 1.50	0.01	gpm	Injector flow rates are determined upon the injector type previously programmed. Should it be necessary it can be overridden by OEM/installer.
	Rinse 0.01 to 2.50	0.01	gpm	

Parameter description	Range of values	Default value	Units of measure	Notes
Refill control	0.14 0.33 1.3	-	gpm	Refill controller flow rate is automatically chosen upon the injector type previously programmed. Should it be necessary it can be overridden by OEM/installer.

### 6.6.8.2 OEM setting menu access

**Info**



**Access to this menu is PIN code protected.**

Refer to PIN code settings menu [→Page 84].

If prompted, enter the PIN code (1201 default) and validate.

1. Press  to start entering the PIN code.
2. Using  and , scroll through the different possible values to set the 1<sup>st</sup> PIN digit.
3. Press  to validate the 1<sup>st</sup> PIN digit setting.
4. Repeat the two previous steps to set the next three PIN digits.
5. Press  or  to display the parameters.



### 6.6.8.3 Valve type

Select the valve.

Options:

- 368;
- 255;
- 263;
- 268 (default);
- 269;
- 278;
- 273.

1. Press  to select the parameter.
2. Using  and , scroll through the different possible values to select the valve.
3. Press  to validate the selection.
4. Press  or  to display the previous/next parameter.



#### 6.6.8.4 Regeneration efficiency

Select the regeneration efficiency.

Regeneration efficiency options:

- High;
- Standard (Default).

1. Press  to select the parameter.
2. Using  and , scroll through the different possible values to select the regeneration efficiency.
3. Press  to validate the selection.
4. Press  or  to display the previous/next cycle time.

Regen Efficiency  
 Standard i

#### 6.6.8.5 Customized text

Activate and enter the customized text.

Customized text options:

- No (Default);
- Yes.

Text options:

- Line 1, 16 characters/numbers;
- Line 2, 16 characters/numbers.

1. Press  to select the parameter.
2. Using  and , scroll through the different possible values to activate/deactivate customized text.
3. Press  to validate the activation.
4. Using  and , scroll through the different possible values to select the character/number.
5. Press  to validate the selection.
6. Repeat the two previous point of this procedure as needed.
7. Press  or  to display the previous/next parameter.

Customized text activation

Customized Text  
 No

Customized text typing









Custom Text\_1  
 Custom Text\_2

#### 6.6.8.6 Meter type

Select and set the meter type.

Meter type options:

- Autotrol (Default);
- K factor (0.1 to 100.0);
- Pulse equivalent (1 to 1'000 l or gal).

1. Press  to select the parameter.
2. Using  and , scroll through the different possible values to select the meter type.
3. Press  to validate the selection.
4. If necessary, using  and , scroll through the different possible values to set the meter.
5. Press  to validate the setting.
6. Press  or  to display the previous/next parameter.

**Meter type selection**

Meter Type  
Autotrol

**Meter setting**

K Factor  
0.01







**6.6.8.7 Injector type****Info**

**The injector type is automatically chosen upon the programmed volume of resin. If needed, this parameter setting can be overridden by the OEM/installer.**

Select the injector type.

Injector options:

- Injector E;
- Injector F;
- Injector G;
- Injector H;
- Injector I;
- Injector K;
- Injector L;
- Injector M;
- Injector N;
- Injector Q;
- Injector R.

1. Press  to select the parameter.
2. Using  and , scroll through the different possible values to select the injector type.
3. Press  to validate the selection.
4. Press  or  to display the previous/next parameter.

Injector Type  
Injector E

### 6.6.8.8 Injector flow

#### Info



The injector flow rate is determined upon the injector type previously programmed. Should it be necessary it can be overridden by OEM/installer.

Set the injector flow.

Injector flow options:

- Brine draw (0.01 to 1.50 gpm);
  - Rinse (0.01 to 2.50 gpm).
1. Press  to select the parameter.
  2. Using  and , scroll through the different possible values to set the injector flow rate.
  3. Press  to validate the setting.
  4. Press  or  to display the previous/next parameter.

Injector Flow  
0.01 GPM

### 6.6.8.9 Refill controller

#### Info



The refill controller flow rate is automatically chosen upon the injector type previously programmed. Should it be necessary it can be overridden by OEM/installer. Set the refill control.

Refill control options:

- 0.14 gpm;
  - 0.33 gpm (Default);
  - 1.3 gpm.
1. Press  to select the parameter.
  2. Using  and , scroll through the different possible values to select the refill controller.
  3. Press  to validate the selection.
  4. Press  or  to display the previous/next parameter.

Refill Control  
0.33 GPM

## 6.6.9 Reset menu

### 6.6.9.1 Reset menu access

#### Info



Access to this menu is PIN code protected.

Refer to PIN code settings menu [[→Page 84](#)].

If prompted, enter the PIN code (1201 default) and validate.

1. Press  to start entering the PIN code.
2. Using  and , scroll through the different possible values to set the 1<sup>st</sup> PIN digit.
3. Press  to validate the 1<sup>st</sup> PIN digit setting.
4. Repeat the two previous steps to set the next three PIN digits.
5. Press  or  to display the parameters.

Enter PIN  
XXXX

### 6.6.9.2 Reset

Reset all the parameters to factory values.

Reset options:

- No (Default);
- Yes.

1. Press  to select the parameter.
2. Using  and , scroll through the different possible values to select the option.
3. Press  to validate the selection.
  - ⇒ If **No** was selected, controller goes back to **Settings** menu.
  - ⇒ If **Yes** was selected, continue this procedure.
4. Press  to reset all the parameters to factory values.
  - ⇒ Controller goes back to **Quick Start-up** menu.

Reset selection

Reset Parameters  
No



Reset controller

Confirm Reset?  
Yes

## 6.7 Diagnostic menu

### 6.7.1 Diagnostic menu access

The diagnostic menu can be accessed in two ways:









- From the service mode by pressing  and .
- From the Settings menu by selecting the diagnostic menu.

### 6.7.2 Data submenu selection

Select the desired data submenu and consult the selected submenu parameters.

Data submenus:

- Error log;
- Regeneration information;
- Water usage history;
- Status.

1. If necessary, press  to come back to **Service** screens.
2. Press  +  to display **Diagnostics** submenus.
3. Using  and , scroll between the different submenus to select the one to consult.
4. Press  to validate the selection.
5. Using  and , scroll to consult the different submenu information.
6. Press  to come back to **Diagnostics** menu.
7. Repeat this procedure from its third point as needed

#### Service screen

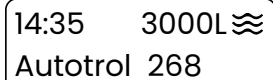

#### Error log screen



#### Regeneration information screen



#### Water usage history screen









#### Status screen



### 6.7.3 Error log submenu

#### 6.7.3.1 Error log

Display the error log.

- Error type and occurrence date.
1. Press  to display the error log.
  2. Using  and , scroll to consult the error list.
  3. Press  to come back on **Error log** submenu.
  4. Press  or  to display the previous/next parameter.

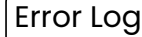







Refer to Troubleshooting [→Page 118] for more information about detectable errors and their display.

#### 6.7.3.2 Clear error log

Clear the error log.

Clearing options:

- Yes;
  - No (Default).
1. Press  to select the parameter.
  2. Using  and , scroll through the different possible values to select the desired option.
  3. Press  to validate the selection.
  4. Press  to come back on **Error log** submenu.
  5. Press  or  to display the previous/next parameter.







### 6.7.4 Regeneration information

Check the regeneration information.

Information displayed:

- Volume since last regeneration (Water usage since last regeneration);
- Last regeneration date (When last regeneration occurred);
- Last regeneration time;
- Last regeneration type (Manual regeneration, override regeneration, meter initiated regeneration, remote regeneration);
- Number of regeneration (Manually and system initiated regenerations the system has gone through since last reset);
- Regeneration interval (Average duration between regeneration based on the past four regenerations).



1. Press  to display the regeneration information.
2. Using  and , scroll to consult the regeneration information.
3. Press  to come back on **Diagnostics** menu.

**Volume since last regeneration**

Volume Since  
Last Regen 3000 L

**Last regeneration date**

Last Regen Date  
01 Jan 2024

**Last regeneration time**

Last Regen Time  
02:00 hr

**Last regeneration type**

Last Regen Type  
Manual

**Number of regenerations**

Number Of Regen  
12

**Regeneration interval**





Regen Interval  
6 Days

### 6.7.5 Water usage history

Check the water usage history.

Information displayed:

- Totalizer (Total volume of water used since last reset);
- Average Monday usage (last 4 Mondays);
- Monday daily usage (current past Monday);
- Average Tuesday usage (last 4 Tuesday);
- Tuesday daily usage (current past Tuesday);
- Average Wednesday usage (last 4 Wednesday);
- Wednesday daily usage (current past Wednesday);
- Average Thursday usage (last 4 Thursday);
- Thursday daily usage (current past Thursday);
- Average Friday usage (last 4 Friday);
- Friday daily usage (current past Friday);
- Average Saturday usage (last 4 Saturday);
- Saturday daily usage (current past Saturday);
- Average Sunday usage (last 4 Sunday);
- Sunday day daily usage (current past Sunday).

1. Press  to display the water usage history.
2. Using  and , scroll to consult the water usage information.
3. Press  to come back on **Diagnostics** menu.

**Total volume of water used**

Total Flow  
10000 L

**Average of a day of the week usage**

Day Of The Week  
Average Usage 142L

**Last day of the week daily usage**





Day Of The Week  
Daily Usage 1432L

### 6.7.6 Status

Check the system status.

Information displayed:

- Software version;
- Last setting change (Date and time of the last update to master **Settings**);
- Resin volume;
- Remaining salt % (If salt alert on);
- Number of regenerations to salt alert (Remaining, if salt alert on);
- Instant flow rate;
- Current flow rate;
- Peak flow rate (Maximum flow rate of water along with date and time of occurrence, since last reset);
- Next regeneration date;
- Reserve (Reserve volume based on the reserve type selected under master settings) (Only available for meter delayed regeneration type);
- Next maintenance schedule (When next maintenance is scheduled).

1. Press  to display the status.
2. Using  and , scroll to consult the status information.
3. Press  to come back on **Diagnostics** menu.

**Software version**

SW/HW  
Version 01.43/3

**Last set change**

Last Setting Change  
01 Jan 2024

**Resin volume**

Resin volume  
20 L

**Remaining salt**

Remaining Salt  
%

**Number of regenerations to salt alert**

Number Of Regen  
To Salt Alert 12

**Instant flow rate**

Instant Flow Rate  
5 L/min

**Peak flow rate**

Peak Flow Rate  
123 L/min

**Next regeneration date**

Next Regen  
01 Jan 2024

**Reserve**

Reserve  
300 L

**Next maintenance**

Next Maintenance  
01 Jan 2024

## 7 Commissioning

### Info



This chapter is available for standard regeneration flows. Contact your supplier if the actual regeneration is not standard and if you need assistance.

### 7.1 Air purge, water filling and waterproofness inspection

#### 7.1.1 Starting-up the water softener

Once the initial programming has been done, the water softener must be started-up, first purging the air out will filling the device with water.





### Caution - material



**Do not rotate the camshaft by hand or damage to the unit may occur.**

Use the controller to take the camshaft electronically through the cycles.

Follow these steps carefully:

1. Remove the cover from the valve. Removing the cover will allow you to see that the camshaft is turning, and in which cycle the camshaft is currently positioned.
2. With the supply water for the system still turned off, position the bypass valve to the **Non-bypass** (normal operation) position.
3. Press  +  to open **Regeneration** menu.
4. Using  and , scroll to select **Now** and start the regeneration immediately.
5. Press  to initiate a manual regeneration.  
While the motor starts rotating the camshaft the controller displays **Positioning in Backwash**.  
Once the cycle position is reached, the controller displays the actual position and the remaining time in this cycle.
6. Fill the media tank with water.
  - ⇒ While the controller is in **Backwash**, open the water supply valve very slowly to approximately the  $\frac{1}{4}$  open position and unplug the electrical socket of the controller so that the valve stays in this position for the whole filling time.

### Info



**If opened too rapidly or too far, media may be lost out of the tank into the valve or the plumbing. In the  $\frac{1}{4}$  open position, you should hear air slowly escaping from the valve drain line.**

- ⇒ When all of the air has been purged from the media tank (water begins to flow steadily from the drain line), open the main supply valve all of the way. This will purge the final air from the tank.
- ⇒ Allow water to drain out until the water runs clear from the drain line. This purges any refuse from the media bed.
- ⇒ Turn off the water supply and let the system stand for about 5 minutes. This will allow any trapped air to escape from the tank.

7. Add water to the brine tank (initial fill) (softener only).

- ⇒ With a bucket or hose, add approximately 15 liters of water to the brine tank. If the tank has a salt platform in the bottom of the tank, add water until the water level is approximately 25 mm (1") above the platform.

#### Tip





**Pentair recommends not putting salt in the tank before the control valve has been started up. With no salt in the tank, it is much easier to view water flow and motion.**

#### Info





**As you advance through each cycle there will be a slight delay before you can advance to the next cycle. The display will show to which cycle while the camshaft is indexing. There may be a pause at Pressurization cycle. This cycle allows the water/air pressure to equalize on each side of the valve discs before moving on.**

#### For 3 cycles filter softener

1. Plug again the controller power supply, slowly open the main inlet valve until fully open position and cycle the valve to the next regeneration cycle by pressing  for 3 seconds.
  - ⇒ The display will show which cycle it indexing to.
2. Leave the valve in the position for approximately 1 minute, and press  for 3 seconds to advance to the next cycle. Repeat until the valve is back to service position.
3. Proceed to the final start-up rinse: open the nearest faucet and let water flow through appliance until the water runs clear.
  - ⇒ This may take from several minutes to 1 hour or more in specific cases.
  - ⇒ The water softener is ready for use.

#### For regenerant using softener

1. Plug again the controller power supply, and with the main inlet valve still closed, cycle the valve to the next regeneration cycle by pressing  for 3 seconds.
  - ⇒ The controller will show **Positioning in brine draw**.
2. Repeat until the controller shows it is positioned in **Refill cycle**.
3. Let the complete refill cycle occur and, if applicable, check to see the float level of the safety brine valve is appropriately set.
  - ⇒ Once the refill cycle is finished, the valve will cycle back to service position.
4. Start again a manual immediate regeneration.
  - ⇒ Refer to Trigger an immediate or delayed regeneration [→Page 102].
5. Repeat pressing  for 3 seconds until the controller shows it is positioned in **Brine draw** position.
6. Check to see that the water in the brine tank is being drawn out of the tank.
  - ⇒ The water level in the tank should recede very slowly.
7. Observe the water being drawn from the regenerant tank for at least 3 minutes. If the water level does not recede, or goes up, check all hoses and tubing connections, if required contact your supplier for further assistance.

8. Once water in the regenerant is confirmed receiving, cycle the valve back to **Service** position by cancelling the regeneration pressing on  button for 3 seconds.
9. With a bucket or a hose, refill the regenerant tank to the approximate level it was showing before the previous draw test.
10. Add regenerant to the regenerant tank.
11. Proceed to the final start-up rinse: open the nearest faucet and let water flow through appliance until the water runs clear.
  - ⇒ This may take from several minutes to 1 hour or more in specific cases.
  - ⇒ The water softener is ready for use.

## 7.1.2 Additional tips

- the preset default time of regeneration is 2:00 AM;
- power supply: The World controller senses the electrical input and decides which is needed;
- the Easy-iQ controller can be programmed to regenerate on specific days of the week;
- should electrical power not be available, the camshaft can be manually rotated counter-clockwise provided the motor has been first dismantled from the valve;

### Caution - material



#### Manually turning the camshaft

Risk to irreversibly damage the motor and the camshaft

Do not turn the camshaft clockwise or while the motor is connected!

- sufficient water pressure and flow rate are required during the regeneration cycles for them to happen properly. Check local conditions versus product specification [[→Page 15](#)].
- make sure the control power source is plugged in. The transformer should be connected to a non-switched power source;
- You can start programming from the beginning by resetting the controller, see chapter Reset menu [[→Page 89](#)].

## 7.2 Sanitization

### 7.2.1 Disinfection of water softeners

The materials of construction of the modern water softener will not support bacterial growth, nor will these materials contaminate a water supply. In addition, during normal use, a softener may become polluted with organic matter, or in some cases with bacteria from the water supply. This may result in an off-taste or odour in the water.

Thus, the softener may need to be disinfected after installation. Some softeners will require periodic disinfection during their normal lifetime. Consult the installing dealer for more information on softener disinfection.

Depending on the conditions of use, the softener type, the type of ion exchanger and the disinfectant available, a choice can be made among the following methods.

## 7.2.2 Sodium or calcium hypochlorite

These materials are satisfactory for use with polystyrene resins, synthetic gel zeolite, greensand and bentonites.

### 5.25% Sodium hypochlorite

If stronger solutions are used, such as those sold for commercial laundries, adjust the dosage accordingly.

#### Dosage

##### For Europe

Polystyrene resin: set 1.25 ml fluid per 1 l of resin.

Non-resinous exchangers: set 0.85 ml fluid per 1 l.

##### For US

Polystyrene resin: set 1.2 fluid ounce (35.5 ml) per ft<sup>3</sup>.

Non-resinous exchangers: set 0.8 fluid ounce (23.7 ml) per ft<sup>3</sup>.

#### Brine tank softeners

Backwash the softener and add the required amount of hypochlorite solution to the well of the brine tank. The brine tank should have water in it to permit the solution to be carried into the softener.

Proceed with the normal regeneration.

#### Calcium hypochlorite

Calcium hypochlorite, 70% available chlorine, is available in several forms including tablets and granules. These solid materials may be used directly without dissolving before use.

Do not let the disinfectant stand for more than 3 hours in the brine tank before the regeneration start.

#### Dosage

##### For Europe

Measure two grains ~ 0.11 ml for 1 l.

##### For US

Measure two grains ~ 0.1 ounce (3 ml) per ft<sup>3</sup>.

#### Brine tank softeners

Backwash the softener and add the required amount of hypochlorite to the well of the brine tank. The brine tank should have water in it to permit the chlorine solution to be carried into the softener.

Proceed with the normal regeneration.

## 8 Operation

### 8.1 Display

#### 8.1.1 Operation display color

The display backlight color changes depending on the system condition:

##### White

In service or in programming mode.

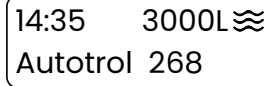

##### Green

During regeneration.

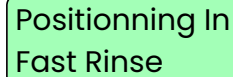

##### Yellow

Minor error detected. Refer to Troubleshooting [→Page 118].

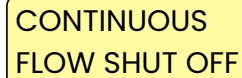

##### Red

Major error detected. Refer to Troubleshooting [→Page 118].



#### 8.1.2 During service

The display shows successively, switching each 5 seconds, the following service screens:

Product type:

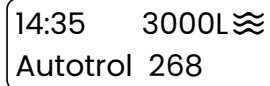

Next regeneration (approximately):

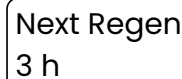

Salt remaining:

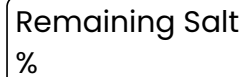



Instant flow rate:

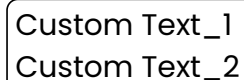

Custom text (if programmed):



These service screens can also be scrolled using  and .



### 8.1.3 During regeneration

The display shows the current cycle with time remaining, or the cycle it's heading towards. A few examples are following:

Backwash cycle:

Backwash  
Time 5 Of 12 min

Going to fast rinse position:

Positioning In  
Fast Rinse

Fast rinse cycle:

Fast Rinse  
Time 2 Of 5 min

Going to brine draw position:

Positioning In  
Brine Draw

## 8.2 Recommendations

- Use only regeneration salts designed for water softening EN973;
- for optimal system operation, the use of clean salt and impurities free is recommended (for example salt pellets);
- do not use ice melt salt, block, or rock salts;
- the sanitizing process (both with liquid and electrochlorination) may introduce chlorine compounds which may reduce the life of the ion exchange resins. Refer to media manufacturer specifications sheet for more information.

## 8.3 Manual regeneration

### Mandatory



**The controller must be in service in order to enable this procedure !**

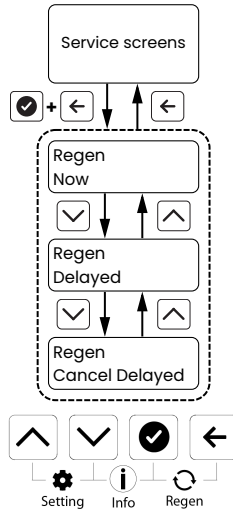

- displays **Manual regeneration** menu from **Service** screens.
- displays **Previous** parameter.
- displays **Next** parameter.
- goes back to **Service** screens.

### 8.3.1 Trigger an immediate or delayed regeneration

Regeneration options:

- Now (Regeneration starts immediately. Controller goes to regeneration screen);
- Delayed (Controller goes back to service screen. Regeneration starts on the scheduled time. See Regeneration time [→Page 68]);
- Cancel (No regeneration and controller goes back to service screen).

1. Press once to access manual regeneration menu.
2. Using and , scroll to select the desired option.
3. Press to confirm selection.

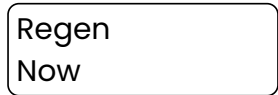

### 8.3.2 To advance regeneration cycles

1. Press to skip to the next regeneration cycle.

### 8.3.3 To cancel a regeneration

1. Press and hold for 3 seconds to cancel the regeneration and return to service position.
  - ⇒ When cancelling a regeneration, if part or all the regenerant has been drawn in the media tank already, make sure sufficient rinse has been done before cancelling the regeneration.

## **8.4 Operation during a power failure**

- All the program settings are stored in a permanent memory;
- current valve position, cycle step time elapsed, and time of day are stored during a power failure, and will be restored upon power restoration;
- time is kept during a power failure and the time of day is adjusted upon restoration of the power (as long as the power is restored within 12 hours);
- the time of day on the main display screen will flash after a power failure once the power is restored until any button is pressed on the keyboard.

## 9 Maintenance

### Mandatory



**Cleaning, maintenance and service operation shall take place at regular intervals and must be done by qualified personnel only in order to guarantee the proper functioning of the complete system.**

Report maintenance done in the Maintenance chapter of the User Guide document.

Failure in respecting above instructions may void the warranty!

### 9.1 General system inspection

#### Mandatory



**Has to be done once a year at minimum.**

#### 9.1.1 Performa 263

##### 9.1.1.1 Water quality

1. Check for raw water analysis and filter's targeted contaminants concentration.
2. Check for treated water analysis and compare with raw water data.

##### 9.1.1.2 Mechanical Checks

1. Inspect general condition of valve and associated ancillaries and check for any leaks, ensure valve connection to piping is made with adequate flexibility as per manufacturer instruction.
2. Inspection of electrical connections, verify wiring connections and search for evidence of overloading.
3. Verify settings of electronic timer, verify regeneration frequency, and make sure the valve configuration is appropriate for media and tank size.
4. Check water meter, if present, report water meter settings and compare with previous inspection.
5. If water meter is present, verify total water consumption compared to previous visit.
6. If pressure gauges are installed before and after softening/filtering system, verify and record static and dynamic pressure, reporting pressure drop. Verify that inlet pressure respects valve and softening/filtering system limits. Verify that pressure drop stay stable year on year, adapt backwash duration if required.
7. If pressure gauges are not present, but suitable points exist, install temporary pressure gauge(s) to perform precedent point.

##### 9.1.1.3 Regeneration test

1. Initiate manual regeneration and overserve flow to drain.
2. Make sure flow rate correspond to DLFC configuration.
3. Check for media loss at the drain during backwash.
4. Check to see if water runs clear at the end of the backwash cycle.

5. Where fitted, check for satisfactory operation of solenoid valve(s) i.e. outlet shut off during regeneration.

## **9.1.2 Performa 268**

### **9.1.2.1 Water quality**

1. Raw water total hardness.
2. Treated water hardness.

### **9.1.2.2 Mechanical checks**

1. Inspect general condition of valve and associated ancillaries and check for any leaks, ensure valve connection to piping is made with adequate flexibility as per manufacturer instruction.
2. Inspection of electrical connections, verify wiring connections and search for evidence of overloading.
3. Verify settings of electronic timer, verify regeneration frequency, make sure the valve configuration correspond to the settings.
4. Check water meter, if present, report water meter settings and compare with previous inspection.
5. Verify total water consumption compared to previous visit.
6. If pressure gauges are installed before and after softening system, verify and record static and dynamic pressure, reporting pressure drop. Verify that inlet pressure respects valve and softening system limits.
7. If pressure gauges are not present, but suitable points exist, install temporary pressure gauge(s) to perform precedent point.

### **9.1.2.3 Regeneration test**

1. Check condition of brine tank and any associated equipment.
2. Check salt level in brine tank.
3. Initiate regeneration test.
  - ⇒ Check brine draw during brine draw stage.
  - ⇒ Check brine tank refill.
  - ⇒ Check operation of safety brine valve, where fitted.
  - ⇒ Check for brine draw off levels.
  - ⇒ Check for resin loss at the drain during regeneration.
  - ⇒ Where fitted, check for satisfactory operation of solenoid, i.e. outlet shut off during regeneration and/or brine line shut off valve(s).
4. Test and record Total Hardness of outlet water from softener vessel(s).

## 9.2 Recommended maintenance plan

### 9.2.1 Performa 263

Items	1 <sup>st</sup> year	2 <sup>nd</sup> year	3 <sup>rd</sup> year	4 <sup>th</sup> year	5 <sup>th</sup> year
Injector & filter****	Clean	Clean	Clean	Clean	Clean/ replace if necessary
DLFC**	Clean	Clean	Clean	Clean	Clean/ replace if necessary
Bypass (if present, contains O-rings**)	-	-	-	-	Clean/ replace if necessary
Flappers	-	-	-	-	Replace
Flappers spring	-	-	-	-	Replace
O-Rings**	Check for watertightness / clean or replace in case of leakage	Check for watertightness / clean or replace in case of leakage	Check for watertightness / clean or replace in case of leakage	Check for watertightness / clean or replace in case of leakage	Check for watertightness / clean or replace in case of leakage
Motor, motor cable and optical sensor harness	Check	Check	Check	Check	Replace
Optical sensor	Check	Check	Check	Check	Replace
Electronic / settings*	Check	Check	Check	Check	Check / replace if necessary
Transformer*	Check	Check	Check	Check	Check / replace if necessary
Turbine (if present, internal or external model)***	Check / clean	Check / clean	Check / clean	Check / clean	Replace
Turbine cable (if turbine present)	Check	Check	Check	Check	Replace
Valve watertightness	Check	Check	Check	Check	Check
Valve to piping watertightness	Check	Check	Check	Check	Check

\* Electronical parts – durability strongly affected by power source quality and stability

\*\* Elastomer durability is strongly affected by raw water concentration in chlorine and its derivate

\*\*\* Wear part

\*\*\*\* Even if the valve is filter configured, the injector is used during regeneration to equalize pressure on both side of flappers and avoid water hammer.

## 9.2.2 Performa 268

Items	1 <sup>st</sup> year	2 <sup>nd</sup> year	3 <sup>rd</sup> year	4 <sup>th</sup> year	5 <sup>th</sup> year
Injector & filter	Clean	Clean	Clean	Clean	Clean/ replace if necessary
Refill controller**	Clean	Clean	Clean	Clean	Clean/ replace if necessary
DLFC**	Clean	Clean	Clean	Clean	Clean/ replace if necessary
1265 Bypass (if present, contains O-rings**)	-	-	-	-	Clean/ replace if necessary
Flappers	-	-	-	-	Replace
Flappers spring	-	-	-	-	Replace
O-Rings**	Check for watertightness / clean or replace in case of leakage	Check for watertightness / clean or replace in case of leakage	Check for watertightness / clean or replace in case of leakage	Check for watertightness / clean or replace in case of leakage	Check for watertightness / clean or replace in case of leakage
Motor, motor cable and optical sensor harness	Check	Check	Check	Check	Replace
Optical sensor	Check	Check	Check	Check	Replace
Inlet Hardness	Check	Check	Check	Check	Check
Residual hardness	Check / adapt mixing screw if necessary	Check / adapt mixing screw if necessary	Check / adapt mixing screw if necessary	Check / adapt mixing screw if necessary	Check / adapt mixing screw if necessary
Electronic / settings*	Check	Check	Check	Check	Check / replace if necessary
Transformer*	Check	Check	Check	Check	Check / replace if necessary

Items	1 <sup>st</sup> year	2 <sup>nd</sup> year	3 <sup>rd</sup> year	4 <sup>th</sup> year	5 <sup>th</sup> year
Turbine (if present, internal or external model)***	Check / clean	Check / clean	Check / clean	Check / clean	Replace
Turbine cable (if turbine present)	Check	Check	Check	Check	Replace
Valve watertightness	Check	Check	Check	Check	Check
Valve to piping watertightness	Check	Check	Check	Check	Check

\* Electronical parts – durability strongly affected by power source quality and stability

\*\* Elastomer durability is strongly affected by raw water concentration in chlorine and its derivate

\*\*\* Wear part.

## 9.3 Recommendations

### 9.3.1 Use original spare parts

#### Caution - material



#### **Risk of damage due to use of non-genuine spare parts !**

To ensure correct operation and safety of the device, only use original spare parts and accessories recommended by the manufacturer.

Usage of non-genuine spare parts voids all warranties.

Parts to keep in stock for potential replacements are motor and optical sensor, controller, transformer, injectors, flapper kit, O-ring kit, refill flow controller and DLFC.

### 9.3.2 Use original approved lubricants

- **Spare part:** p/n 42561 [SILICONE LUBRICANT PACK].

### 9.3.3 Maintenance instructions

- Disinfect and clean the system at least once a year or if the treated water has an off-taste or an unusual odor;
- perform a hardness test every year at both inlet and treated water.



## 9.4 Cleaning and maintenance

### 9.4.1 First steps

Before any cleaning or maintenance procedure, complete the following steps:

#### Mandatory



**These operations must be performed before any cleaning or maintenance procedure !**

1. Unplug the wall-mounted transformer.
2. Shut off water supply or put bypass valve(s) into bypass position.
3. Relieve system pressure before performing any operations.

### 9.4.2 Firmware update

To update the Easy-iQ controller's firmware, refer to USB configuration and update [→Page 56].

### 9.4.3 Injector cleaning

1. Using a Torx key, unscrew and remove the injector cap (4).

#### Caution - material



**Take care not to damage the injector (5).**

2. Using pliers, gently extract the injector (5) from valve body.
3. Clean the injector (5) using compressed air, a soft brush or possibly a pin.
4. Reverse above procedure steps to rebuild.

### 9.4.4 Refill controller cleaning

1. Using a Torx key, unscrew and extract the refill controller (3).
2. Clean the refill controller (3) with a soft brush.
  - ⇒ Make sure the refill controller groove is perfectly clean.
3. Check for O-rings integrity.
4. Check for ball (2) integrity (if present).
5. Clean the refill controller chamber (1) before reinserting the refill controller (3).
6. Reverse above procedure steps to rebuild.

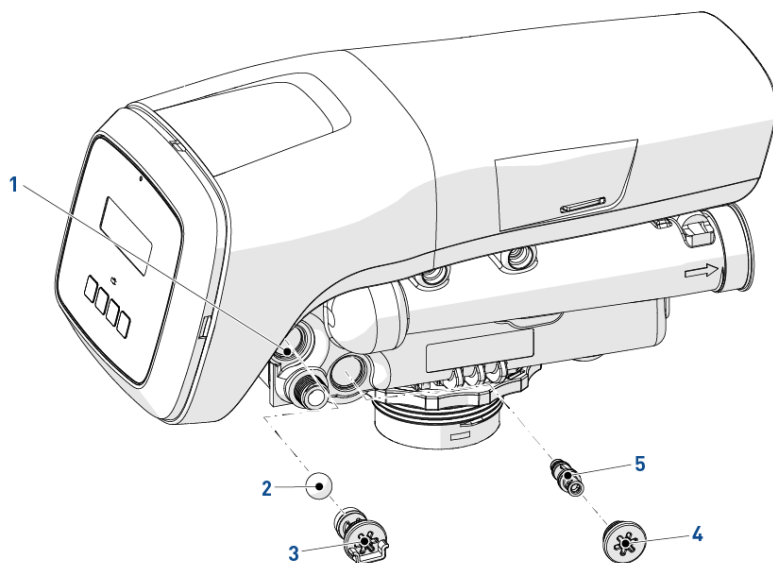

### 9.4.5 Injector screen cleaning

1. Using a Torx key, unscrew and extract the injector screen cap (4).
2. Unclip the white plastic basket (5) and clean it with a soft brush.
  - ⇒ Use of descaling agent such as white vinegar might be required in case of impurities on the plastic basket (5).
3. Check for O-rings integrity before reinserting the injector screen cap (4).
4. Reverse above procedure steps to rebuild.

### 9.4.6 Backwash controller cleaning

1. Using a Torx key, unscrew and extract the backwash flow controller (3).
2. Clean the backwash controller (3) using a soft brush or compressed air.
3. Check for O-rings integrity before reinserting the backwash controller (3).

#### Info



#### Note

Depending on the backwash controller size, it may be of a different type to that shown below. If the model fitting the valve is with the ball (2), make sure to clean the backwash controller grooves and backwash controller chamber (1). Also check for ball (2) integrity before reinserting.

4. Reverse above procedure steps to rebuild.

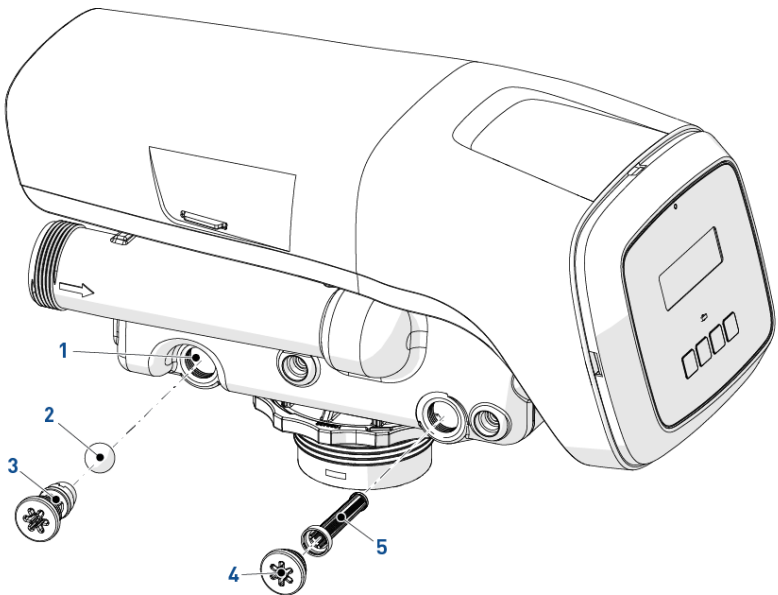

### 9.4.7 Valve cover disassembly

1. Unlock the cover **(1)** from the slide clips **(2)** (one on each side of the valve).
2. Lift the cover **(1)**.
3. Reverse above procedure steps to rebuild.

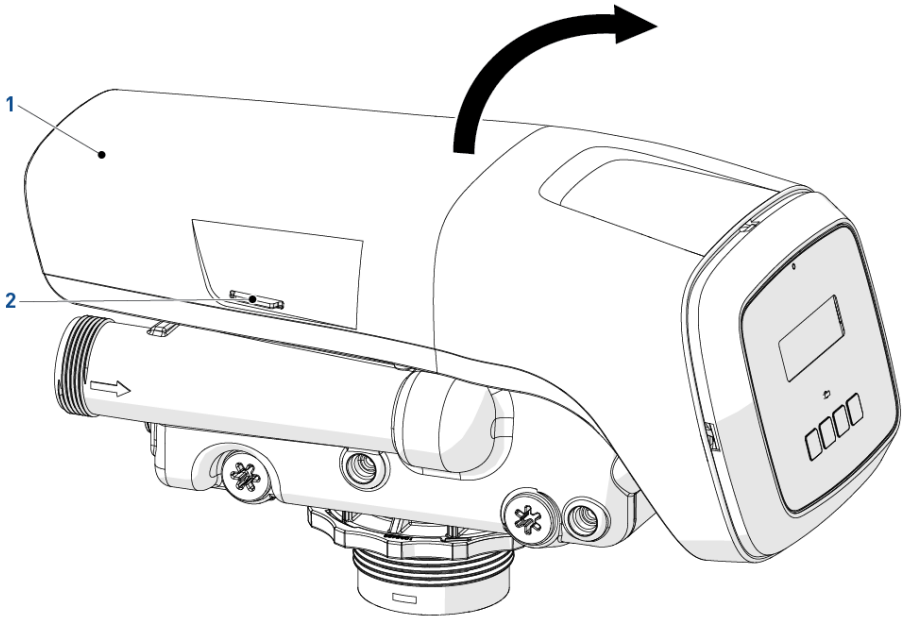

### 9.4.8 Motor and camshaft replacement

1. Remove the white locking pin (2) securing the motor (3).
2. Turn the motor (3) counter clockwise and slide it out of its position.
3. Slide the camshaft (1) backwards until it is released from its mounting boss, then lift it up.

#### Info



#### Note

To replace the motor, you also have to disconnect the optical sensor cable. See Optical sensor and controller replacement [→Page 114].

4. Reverse above procedure steps to rebuild.

#### Caution - material



When reassembling the camshaft (1), place it in the centering hole and use the arrows on the top plate and the camshaft to align the camshaft.

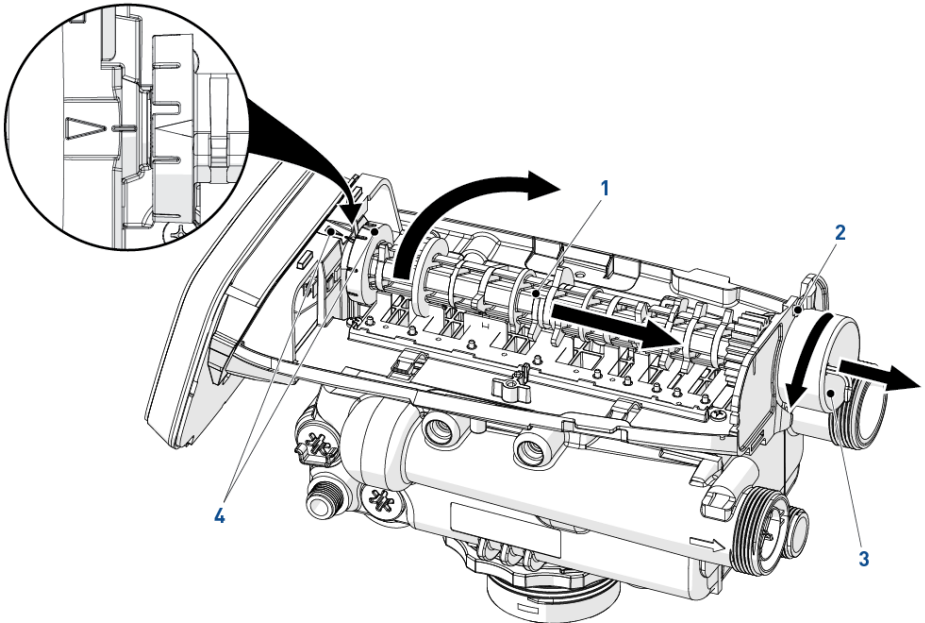

## 9.4.9 Optical sensor and controller replacement

### Info



#### Note

To remove the optical sensor, you first have to disassemble the camshaft. See Motor and camshaft replacement [→Page 113].

1. The optical sensor (2) is clipped on the front edge, gently press on the clips to release the optical sensor (2) from its location.
2. Press the controller locking pad (4) and slide the controller (3) out of its position.
3. Disconnect the cables from the controller by pressing on the clip and pulling them.
4. Remove the motor, cables and optical sensor assembly to change them.
5. Reverse above procedure steps to rebuild.

### Caution - material



**When refitting, always use the cables guide (1) to secure the cables. This will prevent the cables from being crushed or cut when closing the cover or by the camshaft during regeneration cycles.**

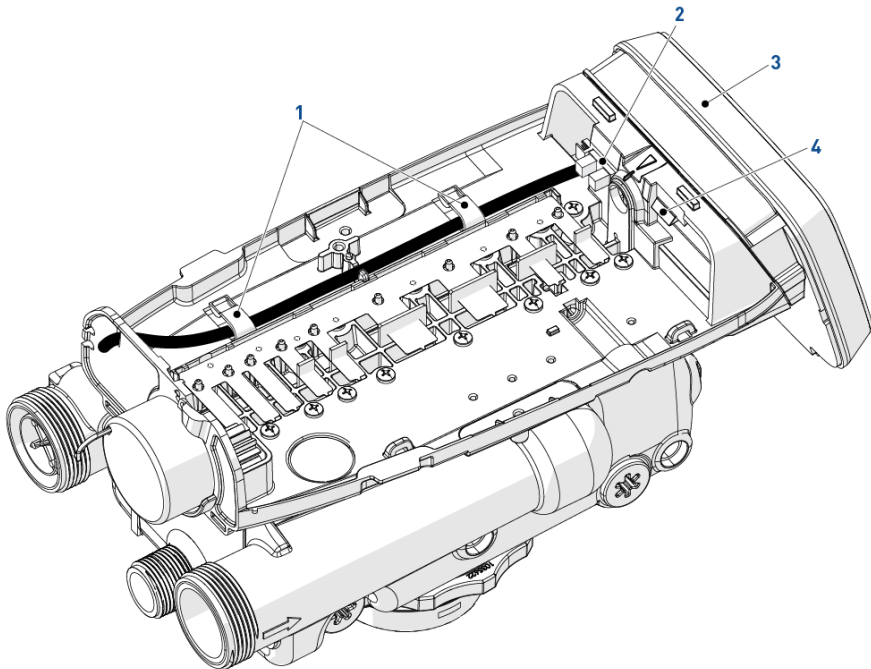

### 9.4.10 Turbine cleaning or replacement

**Info**



**Note**

Depending on the valve installation, the turbine may not be present (optional equipment).

1. Remove the turbine cable (2) by pushing it up and pulling it from the other side.
2. Remove the turbine cable (2) from the cable guide (1).
3. Using pliers, gently extract the turbine (3) from the outlet pipe (4) of the valve.
4. Clean the turbine (3) using a soft cloth and a brush.
5. Reverse above procedure steps to rebuild.

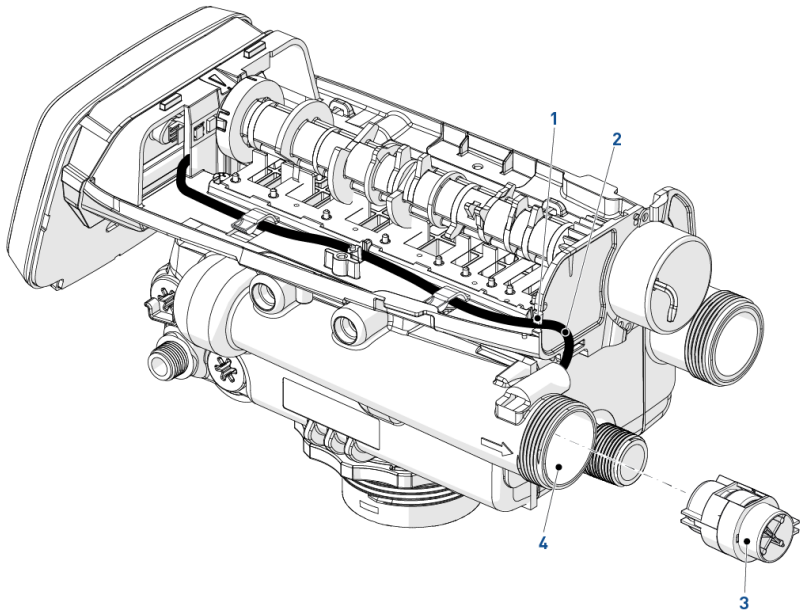

### 9.4.11 Top plate, flapper spring and flappers replacement

 **WARNING**



**Beware of sharp edges.**

Use of protective glove is highly recommended to remove the spring (3).

1. Using a flat screwdriver, release the flapper springs (2) one by one and then remove the spring (3).
2. Loosen all top plate screws (1).
3. Remove the top plate (4) from the valve.
4. Clean or replace the flappers (5) if needed.

**Caution - material**



**The outline of the flapper seat can be seen on the flapper side.**

If the outline is irregular, this may indicate that debris is or has been preventing the flapper (5) from closing, and potential damage.

5. Reverse above procedure steps to rebuild.

**Caution - material**



**When refitting the top plate (4), always follow the screwing order below.**



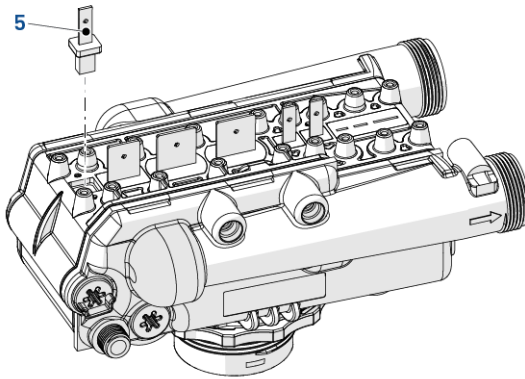
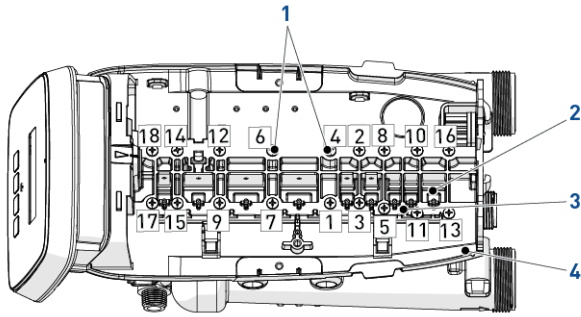

## 10 Troubleshooting

### 10.1 Error display color

The background color of the display changes depending on the error type:

#### Yellow

System presents a minor error.

**CONTINUOUS  
FLOW SHUT OFF**

#### Red

System presents a major error.

**Motor Stall**

In case the controller detects an alert whether yellow or red type, the alert display will override the service screens.

### 10.2 Easy-iQ controller

Message	Cause	Solution
Motor Stall No Changes Detected in the Optical Sensor for 6 Seconds	The motor is on, but no encoder pulses are detected within a given duration while homing.	Check the wire connection and trigger a manual regeneration.
Motor Run-On No CAM Switch Change Detected	The motor is on, but no encoder pulses are detected or CAM switches change state within a given duration.	Verify correct valve type is chosen. Trigger a manual regeneration.
Optical Sensor Undesired changed detected by the optical sensor	The motor is off, but additional encoder pulses are detected.	Trigger a manual regeneration.
Over-Current Motor over-current is detected	Motor current exceeds thresholds.	Trigger a manual regeneration.
Flow Meter Error Continuous Flow Detected	Flow exceeded specified threshold for a specific duration.	There might be a leakage in house piping. Proceed with appropriate investigation and close main inlet water valve if necessary.
100 days without regen	100 days have expired without a regeneration.	Manually initiate a regeneration and contact your installer to investigate the root cause as to why no automatic regeneration occurred in the past 100 days.

Message	Cause	Solution
Service required	Service Interval timer has expired.	From within Master Settings, navigate to the Assistance/Mainten. Interval screen and set a new Service Interval time.
Salt alert	Salt alert countdown reach zero.	Press any button and load the salt.

### 10.3 Valve

Issue	Cause	Solution
Brine tank overflow.	Uncontrolled brine refill flow rate.	Remove brine controller to clean ball and seat.
	Air leak in brine line to air check.	Check all connections in brine line for any leaks.
	Drain control clogged with resin or other debris.	Clean drain control.
Flowing or dripping water at drain or brine line after regeneration.	Valve stem return spring is weak.	Replace the spring.
	Valve disc cannot close because of debris.	Remove debris.
Hard water leakage after regeneration.	Improper regeneration.	Control brine dosage setting and repeat regeneration.
	Leaking of external bypass valve.	Replace bypass valve.
	O-ring around riser pipe damaged.	Replace O-ring.
	Incorrect capacity.	Verify appropriate brine amount and system capacity.
Valve controller will not draw brine.	Low water pressure.	Control and adjust setting according to instructions.
	Restricted drain line.	Remove restriction.
	Injector plugged.	Clean injector and screen.
	Injector defective.	Replace injector and cap.
	Valve disc 2 and/or 3 not closed.	Remove foreign matter from the disc. Check if the disc can close by pushing on stem. Replace the disc if needed.
	Air check valve prematurely closed.	Put controller momentarily into brine refill (C8 - cycle). Replace or repair air check if needed.
Valve controller will not regenerate automatically.	AC transformer or motor are not connected.	Connect the power.
	Defective motor.	Replace motor.

Issue	Cause	Solution
Valve system regenerates at wrong time of day.	Controller set incorrectly.	Correct time setting according to instructions. See Regeneration time [→Page 68].
System using more or less salt than brine setting.	Foreign matter in valve causing incorrect flow rates.	Remove brine controller and flush out foreign matter. Then advance controller to brine cycle (C2) to clean valve (after so doing controller goes to "2nd fast rinse" cycle (C7) to remove any brine from tank).
Intermittent or irregular brine draw.	Low water pressure.	Set pump to maintain 1.4 bar at softener.
	Defective injector.	Replace injector.
No conditioned water after regeneration.	No brine in brine tank.	Add brine to brine tank.
	Injector plugged.	Clean injector and screen.
	Air check valve closes prematurely.	Put controller momentarily into brine cycle (C2). Replace or repair air check if needed.
Backwashes or purges at excessively low or high rate.	Incorrect drain control used.	Replace with correct size controller.
	Foreign matter affecting valve operation.	Remove drain control and clean ball and seat.
No water flow display when water is flowing on Easy-iQ controller.	Bypass valve in bypass.	Shift bypass valve to non-bypass position.
	Meter probe disconnected or not fully connected to meter housing.	Fully insert probe into meter housing.
	Restricted meter turbine rotation due to foreign matter in meter.	Remove meter housing, free up turbine and flush with clean water. Turbine should spin freely. If not, replace meter.
Run out of conditioned water between regenerations.	Improper regeneration.	Control brine dosage set and repeat regeneration.
	Incorrect brine setting.	Set salt dosage to proper level. See Salt dosage [→Page 60].
	Incorrect hardness or capacity settings.	Set to correct values. See Hardness [→Page 60].
	Water hardness has increased.	Set hardness to new value. See Hardness [→Page 60].
	Restricted meter turbine rotation due to foreign matter in meter.	Remove meter housing, free up turbine and flush with clean water. Turbine should spin freely. If not, replace meter.

Issue	Cause	Solution
Brine tank overflow.	Brine valve disc 1 being held open by foreign matter.	Manually operate valve stem to flush away obstruction.
	Valve disc 2 not closed during brine draw causing brine refill.	Flush out foreign matter holding disc open by manually operating valve stem.
	Air leak in brine line to air check.	Check all connections in brine line for any leaks.
	Improper drain control for injector.	Use of small drain control with larger injector will reduce draw rates.
	Drain control clogged with resin or other debris.	Clean drain control.

# 11 Spare parts

## 11.1 Valve parts list

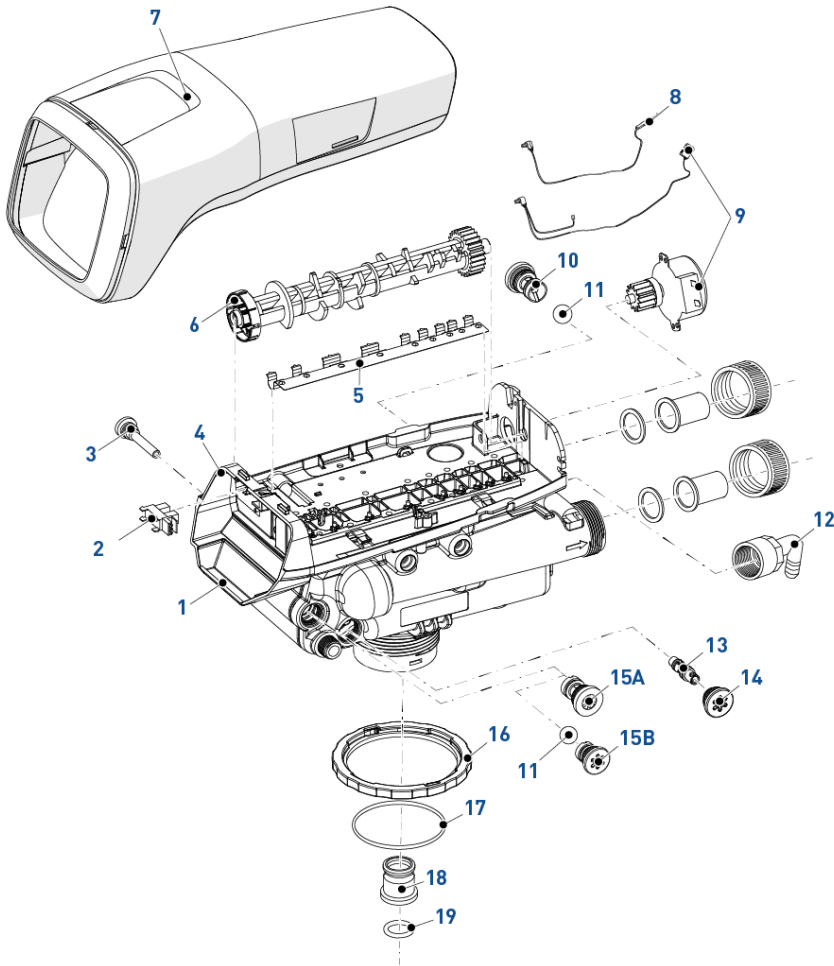

Item	Part number	Description	Assembly quantity
1	1255104	Valve assy without flow controllers (EU)	1
-	1244651	Valve assy without flow controllers with prop-65 label (NAM)	1
2	1235373	Module, sensor, photo interrupter	1
3	1000226	Screen/cap assy with o-ring	1
4	1235338	Top plate, 268/700 series valves	1
5	1235339	Valve disc spring, one piece, Performa	1

Item	Part number	Description	Assembly quantity
6	1235352	Performa Logix camshafts, 263 - 268/700 - 860 series valve, STD, black	1
7	4000816	Easy-iQ cover assembly	1
8	1235446	Turbine cable, Logix short	1
9	1235361	Assy, motor + cable, 700 series controller	1
*	1233187	Motor locking pin (white)	1
10	1000209	Drain controller assy No. 7 (1.2 gpm; 4.5 lpm)	1
*	1000210	Drain controller assy No. 8 (1.6 gpm; 6.1 lpm)	1
*	1000211	Drain controller assy No. 9 (2.0 gpm; 7.6 lpm)	1
*	1000212	Drain controller assy No. 10 (2.5 gpm; 9.5 lpm)	1
*	1000213	Drain controller assy No. 12 (3.5 gpm; 13.2 lpm)	1
*	1000214	Drain controller assy No. 13 (4.1 gpm; 15.5 lpm), no ball	1
*	1000215	Drain controller assy No. 14 (4.8 gpm; 18.2 lpm), no ball	1
*	1030355	External DLFC, 5 gpm (19 lpm)	1
*	1030356	External DLFC, 6 gpm (22.5 lpm)	1
*	1030357	External DLFC, 7 gpm (26.5 lpm)	1
*	1030358	External DLFC, 8 gpm (30 lpm)	1
*	1030359	External DLFC, 9 gpm (34 lpm)	1
*	1030360	External DLFC, 10 gpm (38 lpm)	1
*	1000406	External DLFC, 12 gpm (45 lpm)	1
*	1000407	External DLFC, 15 gpm (56.8 lpm)	1
*	1000409	External DLFC, 20 gpm (75.7 lpm)	1
*	1000269	Plug for backwash flow controller when used with external DLFC	1
11	1030502	Ball, internal DLFC up to nb 12 Included	2
12	1002449	Drain fitting elbow (¾" hose barbed)	1
*	1030334	Plugged refill flow controller - for 263 valve	1
13	1035730	"E" injector (high efficiency) - yellow (6" diameter vessels)	1
*	1035731	"F" injector (high efficiency) - peach (7" diameter vessels)	1
*	1035732	"G" injector (high efficiency) - tan (8" diameter vessels)	1
*	1035733	"H" injector (high efficiency) - lt purple (9" diameter vessels)	1
*	1035734	"J" injector (high efficiency) - lt blue (10" diameter vessels)	1
*	1035735	"K" injector (high efficiency) - pink (12" diameter vessels)	1
*	1035736	"L" injector (high efficiency) - orange (13 - 14" diameter vessels)	1
14	1000269	Injector cap with o-ring	1
15A	1000222	Regenerant refill controller assy, 0.33 gpm, no ball, washer	1

Item	Part number	Description	Assembly quantity
15B	1243510	Regenerant refill controller, 0.33 GPM cone style	1
16	1035622	Tank ring	1
17	1010154	Tank o-ring	1
*	1239760	Blending valve kit	1
*	1033444	Turbine assy	1
*	1041174	Standard/Sev valve disc kit (EU)	1
*	1041174-01	Standard/Sev valve disc kit, prop-65 label (NAM)	1
*	1239979	Cable harness for remote regeneration on 740F	1
18	1001986	13/16" rubber insert (optional)	1
*	1239752	Switch kit, front mount, 5 Amp	1
*	1239754	Switch kit, top plate mount, 5 Amp	1
19	1232370	O-ring EP	1

\* Not shown

## 11.2 Easy-iQ Controller and power supply

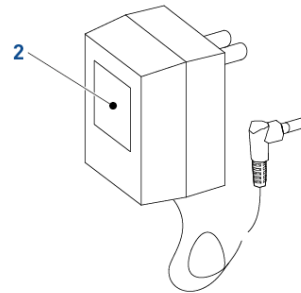
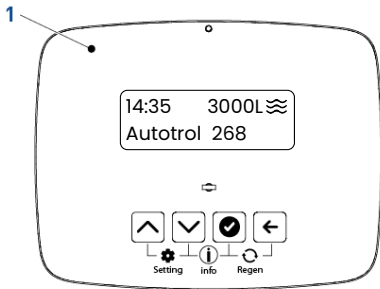

Item	Part number	Description	Assembly quantity
1	4000817	Easy-iQ controller	1
2	1000813	Transformer British plug	1
*	1000814	Transformer European plug	1
*	1000812	Transformer Australian plug	1
*	44149	Transformer American plug	1
*	1000810	Transformer Japanese plug	1
*	44156	Outdoor transformer American plug	1

\* Not shown



## 11.3 1265 Bypass & Connections

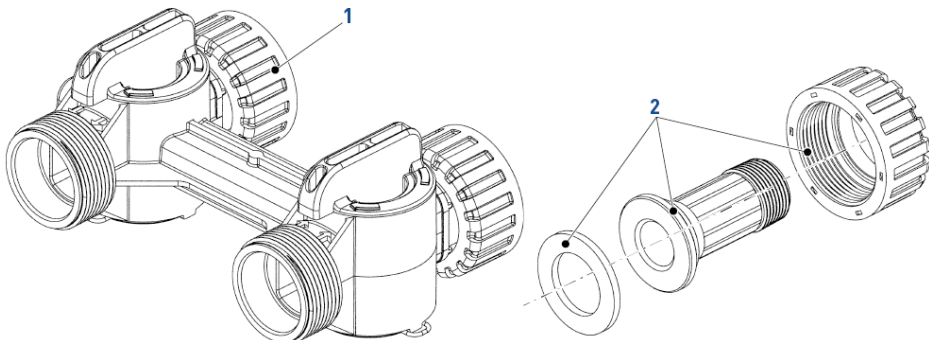

Item	Part number	Description	Assembly quantity
1	1040930	Bypass 1265	1
*	1034302	Repair kit (rotor seals & clips)	1
*	1030541	Gasket for 1" pipe or tube	2
*	1034385	Adapter nut 1 - 1 1/4" bakelite	2
2	3023824	3/4" BSPT stainless steel pipe adapter kit	2
*	3023807	1" BSPT stainless steel pipe adapter kit	2
*	1001608	22 mm copper tube adapter kit	2
*	1001615	32 mm PVC tube adapter kit	2
*	1001614	1" PVC tube adapter kit	2
*	1001613	3/4" PVC tube adapter kit	2

\* Not shown

## 11.4 Valve installation kits

### 11.4.1 Performa 263

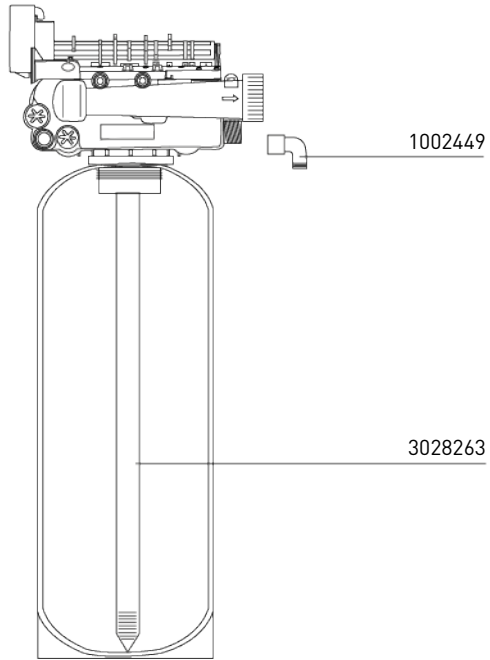

Correct drain line flow control must be fitted depending on media type and vessel size.

Part number	Description	Assembly quantity
1002449	Drain fitting elbow (¾" hose barbed)	1
3028263	Riser tube 1.050"	1

\* Not shown

**11.4.2 Performa 268**

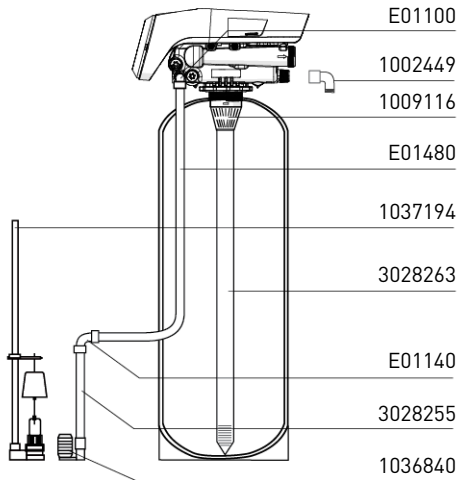

Part number	Description	Assembly quantity
3029817	Kit - 268 consist of: 1002449, 1009116, 3028263, E01100 and 3028255	1
1002449	Drain fitting elbow (3/4" hose barbed)	1
1009116	Upper screen	1
3028263	Riser tube 1.050"	1
E01100	Fitting female elbow 3/8" Fx 3/8" tube	1
3028255	Air check tube 3/8"	1
1037194	Brine tube, 3/8" x 34.75"	1
1036840	Brine valve, 3/8"	1
E01140	Union elbow 3/8" T - 3/8" T	1
E01480	Tubing 3/8" Roll of 30 m	1

## 12 Disposal

The device must be scrapped in accordance with directive 2012/19/EU or the environmental standards in force in the country of installation. The components included in the system must be separated and recycled in a waste recycling center that conforms with the legislation in force in the country of installation. This will help to reduce the impact on the environment, health, safety and help to promote recycling. Pentair does not collect used product for recycling. Contact your local recycling center for more information.



## Notes

**[WWW.PENTAIR.EU](http://WWW.PENTAIR.EU)/[WWW.PENTAIR.COM](http://WWW.PENTAIR.COM) (NAM)**